

VDA NW6/NW8

Steel wire lock Quick connector Show

GA1	NW6-ID6	GA2	NW6-ID6-L	GA3	NW6-ID6-41.5°	GA4	NW6-ID6 male end
							
PA 6.0 ID		PA 6.0 ID		PA 6.0 ID		PA 6.0 ID	
GA5	NW6-ID10	GA6	NW6-ID10-L	GA7	NW6-ID10-41.5°		
							
Rubber 10.0 ID		Rubber 10.0 ID		Rubber 10.0 ID			
HA1	NW8-ID6	HA2	NW8-ID6-L	HA3	NW8-ID6-45°	HA4	NW8-ID8
							
PA 6.0 ID		PA 6.0 ID		PA 6.0 ID		PA 8.0 ID	
HA5	NW8-ID8-L	HA6	NW8-ID8-45°	HA7	NW8-ID8	HA8	NW8-ID8-L
							
PA 8.0 ID		PA 8.0 ID		Rubber 8.0 ID		Rubber 8.0 ID	

快速连接器有O型环和工程塑料件组成，我们需要了解规格以及使用环境，正确为您推荐合适的连接器。



Connectors are supplied with o-rings and plastic material combinations. To determine correct choices, we must have specification and information on operating conditions.

执行标准：SAE J2044-2009 地面车辆推荐规范-液体燃料和气体排放系统用快速连接规范

Superseding J2044 AUG2009 Quick Connect Coupling Specification for Liquid Fuel and Vapor/Emissions Systems

VDA NW6/NW8



Steel wire lock Quick connector Show

HA9	NW8-ID8-45°	HA10	NW8-ID14-180°	HA11	NW8-ID14-90°		
							
	Rubber 8.0 ID	PA 14.0 ID		PA 14.0 ID			

快速连接器有O型环和工程塑料件组成，我们需要了解规格以及使用环境，正确为您推荐合适的连接器。
 Connectors are supplied with o-rings and plastic material combinations. To determine correct choices, we must have specification and information on operating conditions.
 执行标准：SAE J2044-2009 地面车辆推荐规范-液体燃料和气体排放系统用快速连接规范
 Superseding J2044 AUG2009 Quick Connect Coupling Specification for Liquid Fuel and Vapor/Emissions Systems

VDA NW12

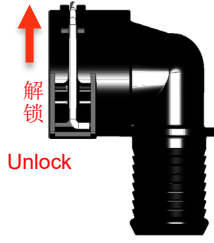
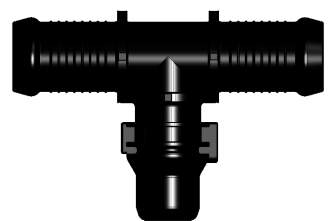
Steel wire lock Quick connector Show

JA1	NW12-ID18	JA2	NW12-ID18	JA3	NW12-ID18-45°	JA4	NW12-ID18 T
							
Rubber 18.0 ID		Rubber 18.0 ID		Rubber 18.0 ID		Rubber 18.0 ID	
JA5	NW12-ID14	JA6	NW12-ID14				
							
PA 14.0 ID		PA 14.0 ID					

NSC 12钢丝扣快速接头展示





Steel wire lock Quick connector Show

NSC-1	NSC12-10-0°	NSC-2	NSC12-12-0°	NSC-3	NSC12-10-90°	NSC-4	NSC12-10-0°
							
Rb 10.0 ID		Rb 12.0 ID		Rb 10.0 ID		Rb 10.0 ID	

快速连接器有O型环和工程塑料件组成，我们需要了解规格以及使用环境，正确为您推荐合适的连接器。
 Connectors are supplied with o-rings and plastic material combinations. To determine correct choices, we must have specification and information on operating conditions.
 执行标准：SAE J2044-2009 地面车辆推荐规范-液体燃料和气体排放系统用快速连接规范
 Superseding J2044 AUG2009 Quick Connect Coupling Specification for Liquid Fuel and Vapor/Emissions Systems

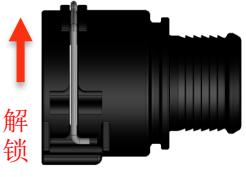
VDA NW16

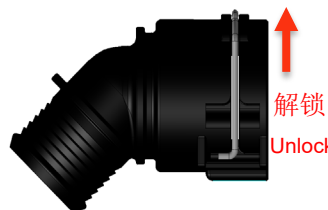
Steel wire lock Quick connector Show

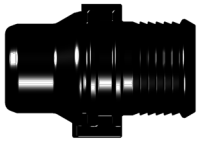
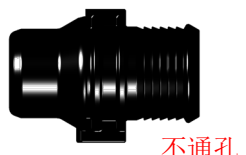
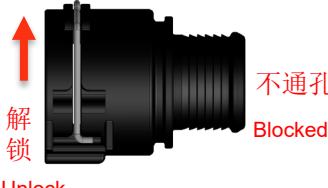
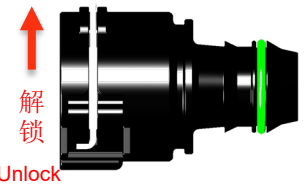
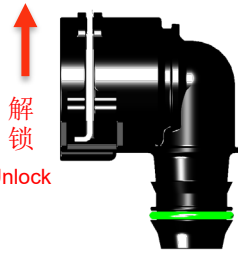
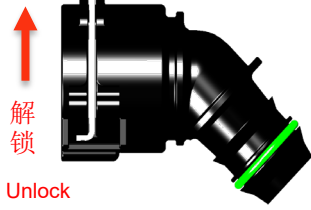
NB1	NW16-ID22	NB2	NW16-ID22	NB3	NW16-ID22-45°	NB4	NW16-ID22-45°
							
Rubber 22.0 ID		Rubber 22.0 ID		Rubber 22.0 ID		Rubber 22.0 ID	
NB5	NW16-ID22-T	NB6	NW16-ID22	NB6-D	NW16 end cap	NB1-D	NW16 end cap
							
Rubber 22.0 ID		Rubber 22.0 ID		NW16 QC		NW16 QC	
NB7	NW16-ID16	NB8	NW16-ID16	NB9	NW16-ID16-45°		
							
PA 19x1.5 ODxWT		PA 19x1.5 ODxWT		PA 19x1.5 ODxWT			

快速连接器有O型环和工程塑料件组成，我们需要了解规格以及使用环境，正确为您推荐合适的连接器。



Connectors are supplied with o-rings and plastic material combinations. To determine correct choices, we must have specification and information on operating conditions.

执行标准：SAE J2044-2009 地面车辆推荐规范-液体燃料和气体排放系统用快速连接规范

Superseding J2044 AUG2009 Quick Connect Coupling Specification for Liquid Fuel and Vapor/Emissions Systems

VDA NW18

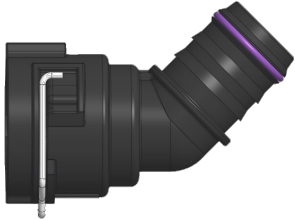
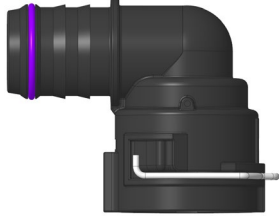
Steel wire lock Quick connector Show

PB1	NW18-ID18	PB2	NW18-ID18-60°	PB3	NW18-ID18-90°	PB5	NW18-ID18
							
PA 17.0 ID		PA 17.0 ID		PA 17.0 ID		PA 17.0 ID	

快速连接器有O型环和工程塑料件组成，我们需要了解规格以及使用环境，正确为您推荐合适的连接器。
 Connectors are supplied with o-rings and plastic material combinations. To determine correct choices, we must have specification and information on operating conditions.
 执行标准：SAE J2044-2009 地面车辆推荐规范-液体燃料和气体排放系统用快速连接规范
 Superseding J2044 AUG2009 Quick Connect Coupling Specification for Liquid Fuel and Vapor/Emissions Systems

VDA NW22

Steel wire lock Quick connector Show

XB5	NW22-ID25	XB6	NW22-ID25	XB7	NW22-ID25		
							
PA 29x2.0 ODxWT		PA 29x2.0 ODxWT		PA 29x2.0 ODxWT			

VDA NW26

Steel wire lock Quick connector Show

XP1	NW26-ID25	XP2	NW26-ID25	XP5	NW26-ID25		
							
PA 29x2.0 ODxWT		PA 29x2.0 ODxWT		PA 29x2.0 ODxWT			
XP3	NW26-ID25	XP4	NW26-ID25				
							
PA 29x2.0 ODxWT		PA 29x2.0 ODxWT					

快速连接器有O型环和工程塑料件组成，我们需要了解规格以及使用环境，正确为您选择合适的连接器。
 Connectors are supplied with o' rings and plastic material combinations. To determine correct choices, we must have specification and information on operating conditions.
 执行标准：SAE J2044-2009 地面车辆推荐规范-液体燃料和气体排放系统用快速连接规范
 Superseding J2044 AUG2009 Quick Connect Coupling Specification for Liquid Fuel and Vapor/Emissions Systems

VDA NW32/NW26/NW40

Steel wire lock Quick connector Show

OB1	NW32-ID20-ID32	OB2	NW32-ID32	OB3	NW32-ID32		
							
Rubber 32/20 ID		Rubber32 ID		Rubber32 ID			
OB4	NW26-ID32	OB5	NW26-ID32				
PA 35x1.5 ODxWT		PA 35x1.5 ODxWT					
YZ1	NW40-ID40	YZ2	NW40-ID40	YZ3	NW40-ID40		
							
PA 44x2.0 ODxWT		PA 44x2.0 ODxWT		PA 44x2.0 ODxWT			