

QUICK CONNECTORS

Product catalog 2025

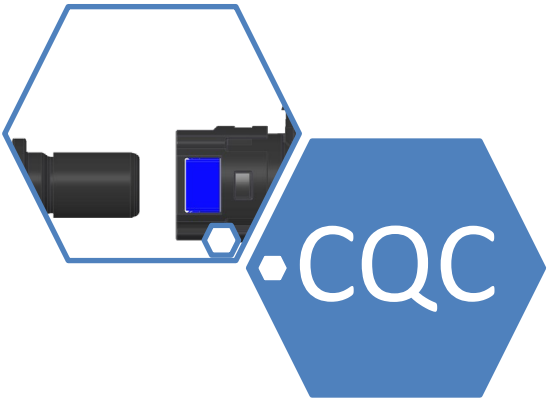

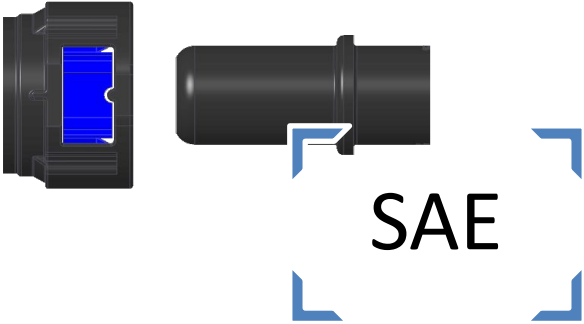

- 塑料件兼有轻量化和耐腐蚀性的优点
- 帮助满足环境/排放的要求
- 零件紧凑且体积小，非常容易使用
- 减少装配周期提高生产力：在售后市场的应用中无需借助工具来解锁
- 针对燃油管路及所有汽车回路拥有着全球最广泛的快速接头产品范围
- 多种角度、形状和直径
- 多功能的快装接头：可以集成多种功能，比如截止阀、调节阀、单向阀、压力调节阀、压力检查阀等
- 所有接头都能满足一定的清洁度标准
- 装配防错装置
- Plastic parts have the advantages of both light weight and corrosion resistance.
- Help to meet environmental/emissions requirements.
- The parts are compact and small, making them very easy to use.
- Reduced assembly cycles and increased productivity: In aftermarket applications, there is no tools needed to unlock.
- It has the world's broadest range of quick couplings for fuel lines and all automotive circuits.
- With multiple angles, shapes, and diameters.
- Multi-functional quick connectors can integrate a variety of functions, such as globe valves, control valves, check valves, pressure regulating valves, pressure check valves, etc.
- All fittings can meet certain cleanliness standards.
- Equipped with error-proofing devices.

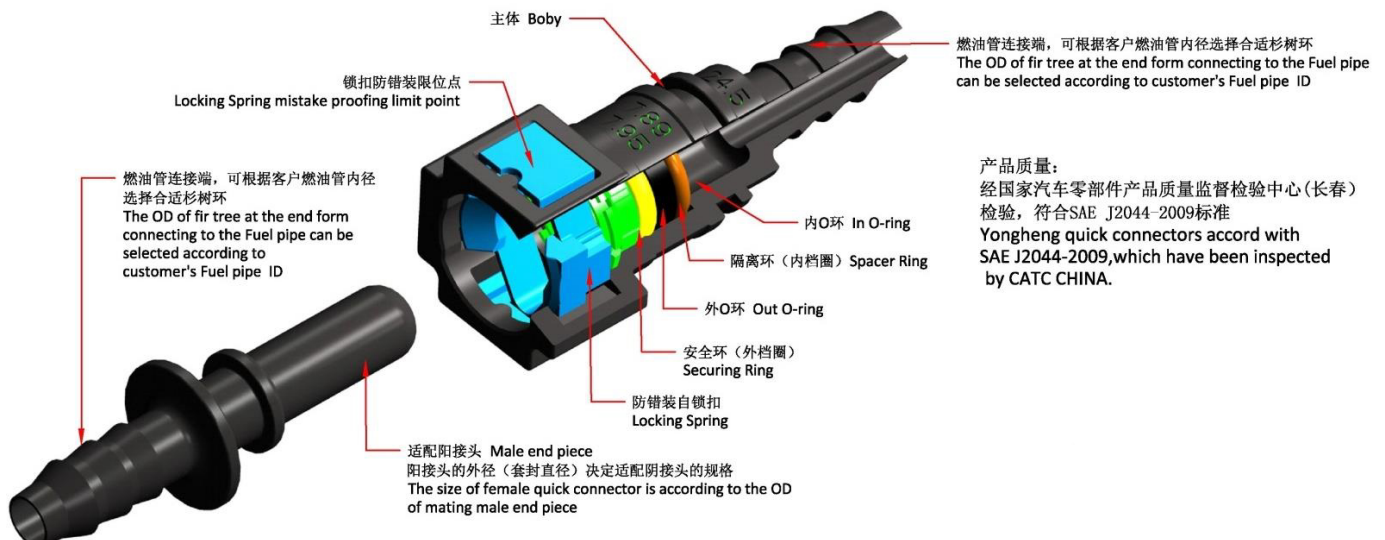
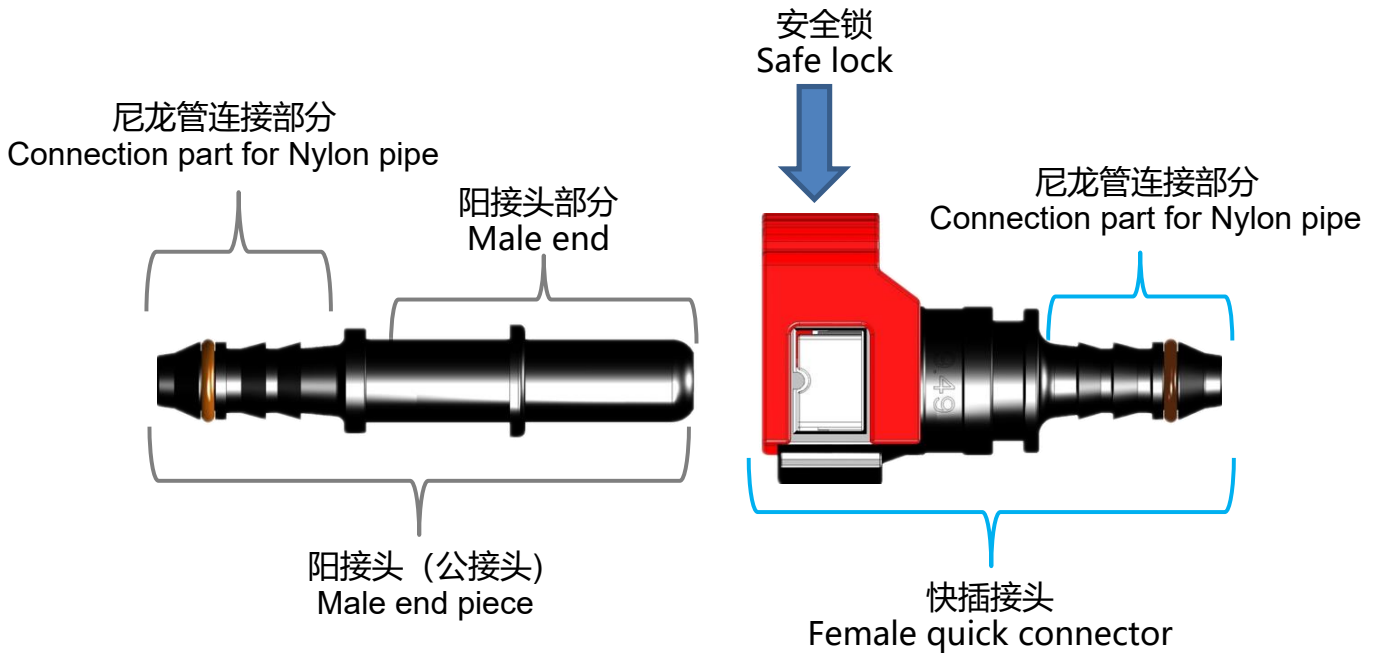

Contents



	QC	Male End	End Cap
SAE	P4		
6.30 - 1/4"	P4	P30	P59
7.89 - 5/16"	P7	P30	P59
9.49 - 3/8"	P14	P30	P59
9.89	P19	P30	P59
11.80 - 12.00	P20	P31	P59
12.61 - 1.2"	P21	P31	P59
15.82 - 5/8"	P23	P31	P59
18.9	P27	-	P59
METRIC	P4		
8.00	-	P30	-
10.00	-	P30	P59
16.00	-	-	-
17.50	P27	-	-
18.00	P27	P31	P59
24.00	P27	-	P59
2-BUTTON COMPACT QC	P34		
CQC	P38		
CQC 10.0	P38	P38	-
CQC 14.0	P38	P38	-
CQC 18.0	P39	-	-
Accessories-End Plug	-	-	P60
Adapter Tee	P42		
Adapter-straight & elbow	P46	-	-

	QC	Male End	Accessories
VDA	P32		
NW6/8	P32	-	-
NW12	P34	-	-
NW14	-	-	-
NW16	P35	P35	-
NW18	P36	-	-
NW20	-	-	-
NW22	P37	-	-
NW24	-	-	-
NW26	P37	-	-
NW32	P37	-	-
NW40	P37	-	-
NW55-61.00	-	-	-
DN	P48		
DN6	P55	-	-
DN14	-	-	-
DN18	-	-	-
230	P56	-	-
Check Valve	P57		
246	P54	-	-
246	P54	-	-
Oil Return connector	P52	-	-
Wiper pipe connector	P51	-	-

产品应用范围

PRODUCT APPLICATION

 燃油系统 (燃油)
Fuel System (Liquid)

 燃油系统 (燃油蒸汽)
Fuel System (Vapor)

 曲轴箱通气管
Crankcase Breather

 离合器
Clutch System

 传动油冷却
Transmission Oil Cooling (TOC)

 动力转向
Power Steering

 涡轮增压器润滑
Turbo Charger Lubrication

 刹车制动真空
Brake Booster Vacuum

 液压制动
Hydraulic Brake

 空气
Air

 空调系统
HVAC

 热管理系统
Thermal Management

 尿素还原系统
Urea SCR System

 多种应用
Other Application

我们能够在定义的温度和压力范围之外的应用条件下提供针对性的解决方案。请随时联系我们。

Please contact us for the solution for other application with special temperature and pressure.



接头的装配 Assembly for quick connectors

- 1、阳接头符合SAE标准，必须没有灰尘和损伤
- 2、阳接头必须沿着接头轴向方向插入（F1）防止偏离轴向，避免导致密封圈移位
- 3、接头必须使用手工插入直到无法插入并听到一声“咔哒”
可涂少量的发动机机油在阳接头的端部。
- 4、为了确保安装到位，必须装配好后通过轻轻推拔快速接头检查是否完全连接好。



- 1, The male end piece must meet SAE standards and must be free of dust and damage.
- 2, The male end piece must be inserted along the axial direction of the joint (F1) to prevent deviation from the axial direction and avoid causing the seal to shift.
- 3, The male end piece must be inserted manually until it cannot be inserted and with a sound ("click"). A small amount of engine oil can be applied to the end of the male end piece.
- 4, In order to ensure that the installation is in place, it must be checked whether it is fully connected by gently pushing and pulling the quick connector after assembly.

F2力检查装配情况 F2 force to check the assembly

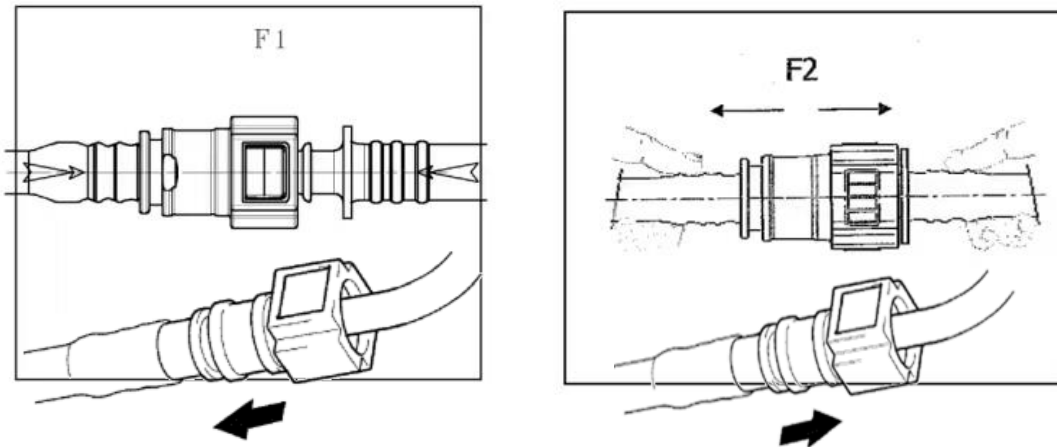

接头的拆卸 Disassembly of quick connectors

- 1、拆卸这些快速接头前，先检查快速接头的燃油管附近是否有泥土等异物，并清除干净。务必用手断开这些尼龙管快速接头。
- 2、当快速接头和燃油管卡紧时，一只手捏紧燃油管，另一只手推和拉快速接头，再将其拔出。**此过程不要使用任何工具。**
- 3、如果有泥土或其他任何异物在被断开的燃油管接头的密封表面，必须清除它们。
- 4、被断开的燃油管和快速接头不能有任何的损坏，并要用塑料袋包好它们以防止任何异物进入管内。

1. Before disassembling these quick connectors, check whether there are any foreign objects near the fuel line connected with quick connectors such as mud, and remove them. Be sure to disconnect these nylon tube quick connectors by hand.
2. When the quick connector and fuel line are clamped, pinch the fuel pipe tightly with one hand, push and pull the quick connector with the other hand, and then pull it out. **Do not use any tools for this process.**
3. If there is mud or any other foreign object on the sealing surface of the disconnected fuel line fitting, they must be removed.
4. The disconnected fuel pipe and quick connectors should not be damaged in any way, and they should be wrapped in plastic bags to prevent any foreign matter from entering the pipe.

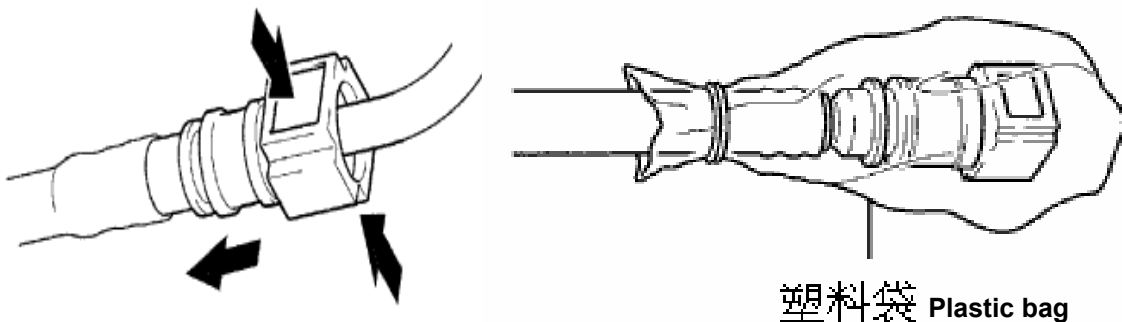



永恒快速接头分类以及零部件材料基本信息











Yongheng Quick Connector basic introduction

Type	Features	Working Temp.	Working Pressure	Methods for Connection	Body Material for Different Application
SAE QC	Safe, convenient and detachable	-30 to 120°C	5~7Bar***	Pressing, hose clamping, welding	Fuel(liquid), fuel (vapor), urea
VDA QC	Safe, convenient and detachable	-40 to 120°C	0~5Bar***	Pressing, hose clamping, welding	Fuel(liquid), fuel (vapor), coolant
CQC	Safe, detachable, small space with large diameter	-40 to 120°C	0~5Bar***	Pressing, hose clamping, welding	Coolant
Wiper QC	Safe, convenient and detachable	-40 to 120°C	0~5Bar***	Hose clamping	Glass cleaner
246 series 230 series	Safe, convenient and detachable	-30 to 120°C	5~7Bar***	Pressing	Fuel(liquid), fuel (vapor), coolant, urea
Check valve	Safe	-30 to 120°C	5~7Bar***	Pressing	Fuel(liquid), fuel (vapor),
QC for oil return pipe	Safe, convenient and detachable	-30 to 120°C	5~7Bar***	Pressing	Fuel(liquid)

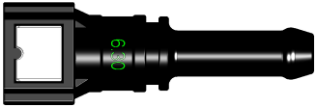
Parts	Material	Application	Color
Body	PA12 GF30	Fuel, urea	Black/grey/nature
	PA66 GF30/35	Coolant, fuel vapor	Black
	PA6/6T GF25	Fuel resistant to high temperatures	Black
	PA4T GF30	Fuel resistant to high temperatures	Black
	POM	Wiper system	Black
Locking Spring	PA11	Fuel, coolant	Grey/ customization
	PA66	Fuel resistant to high temperatures, fuel vapor	Grey/ customization
Securing Ring	PA12 GF30	Fuel, fuel vapor, power steering, urea, air conditioner	Green/ customization
	PA66GF 30/35	Coolant, fuel vapor	Green/ customization
O-rings	FKM/FVMQ/ HNBR/EPDM	Fuel, fuel vapor, power steering, urea, air conditioner, coolant	NA
Valve	FVMQ	Fuel vapor, air	Brown

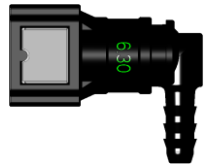
SAE
6.30-1/4"

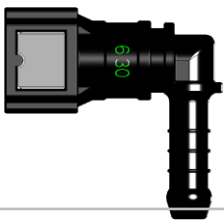
6.30燃油快速接头展示
"Fuel Liquid Quick Connectors Show

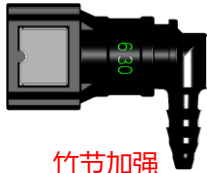
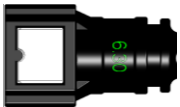
A1	6.30-ID3-180°	A2	6.30-ID3-90°	A3	6.30-ID6-180°	A4	6.30-ID6-90°
							
PA 5x1 OD×WT		PA 5x1 OD×WT		PA 8x1 OD×WT		PA 8x1 OD×WT	
A7	6.30-ID7.5-180°	A8	6.30-ID7.5-90°	A9	6.30-ID4-180°	A10	6.30-ID4-90°
							
Rubber 7.5 ID		Rubber 7.5 ID		PA 6x1 OD×WT		PA 6x1 OD×WT	
A11	6.30-ID6-180°	A12	6.30-ID6-90°	A13	6.30-ID3-90°	A14	6.30-ID3-90°
				 竹节加强		 竹节加强	
Rubber 6.0 ID		Rubber 6.0 ID		PA 5x1 OD×WT		PA 5x1 OD×WT	
DA1	6.30 end cap						
							
Applied to 6.30 male end piece							

快速连接器有O型环和工程塑料件组成，我们需要了解规格以及使用环境，正确为您选择合适的连接器。
Connectors are supplied with o'rings and plastic material combinations. To determine correct choices, we must have specification and information on operating conditions.
执行标准：SAE J2044-2009 地面车辆推荐规范-液体燃料和气体排放系统用快速连接规范
Superseding J2044 AUG2009 Quick Connect Coupling Specification for Liquid Fuel and Vapor/Emissions Systems

**SAE
6.30-1/4"**

**6.30尿素快速接头展示
" SCR Urea Quick Connectors**

U1	6.30-ID3-180°	U2	6.30-ID3-90°	U3	6.30-ID6-180°	U4	6.30-ID6-90°
							
AdBlue Tube 5x1 OD×WT		AdBlue Tube 5x1 OD×WT		AdBlue Tube 8x1 OD×WT		AdBlue Tube 8x1 OD×WT	
U7	6.30-ID7.5-180°	U8	6.30-ID7.5-90°	U9	6.30-ID4-180°	U10	6.30-ID4-90°
							
Rubber 7.5 ID		Rubber 7.5 ID		AdBlue Tube 6x1 OD×WT		AdBlue Tube 6x1 OD×WT	
U11	6.30-ID6-180°	U12	6.30-ID6-90°	U13	6.30-ID3-90°	U14	6.30-ID3-90°
				 Strengthened Fir tree		 Strengthened Fir tree	
Rubber 6.0 ID		Rubber 6.0 ID		AdBlue Tube 5x1 OD×WT		AdBlue Tube 5x1 OD×WT	
HT-A1	6.30-A1 Protection cover	HT-A2	6.30-A2 Protection cover	HT-A3	6.30-A3 Protection cover	HT-A4	6.30-A4 Protection cover
							
适配波纹管外径9.2mm Applied to corrugated pipe with OD of 9.2mm		适配波纹管外径9.2mm Applied to corrugated pipe with OD of 9.2mm		适配波纹管外径13.0mm Applied to corrugated pipe with OD of 13.0mm		适配波纹管外径13.0mm Applied to corrugated pipe with OD of 13.0mm	

快速连接器有O型环和工程塑料件组成，我们需要了解规格以及使用环境，正确为您推荐合适的连接器。
Connectors are supplied with o-rings and plastic material combinations. To determine correct choices, we must have specification and information on operating conditions.
执行标准：SAE J2044-2009 地面车辆推荐规范-液体燃料和气体排放系统用快速连接规范
Superseding J2044 AUG2009 Quick Connect Coupling Specification for Liquid Fuel and Vapor/Emissions Systems

SAE
6.30-1/4"

6.30尿素快速接头展示
" SCR Urea Quick Connectors

AH1	6.30-OD5-180°	AH2	6.30-OD5-90°	AH3	6.30-OD4-180°	AH4	6.30-OD4-90°
							
AdBlue Tube 5x1 OD×WT		AdBlue Tube 5x1 OD×WT		AdBlue Tube 4x1 OD×WT		AdBlue Tube 4x1 OD×WT	
AH5	6.30-OD5-180°	AH6	6.30-OD5-90°	AH7	6.30-OD8-180°	AH8	6.30-OD8-90°
							
AdBlue Tube 5x1 OD×WT		AdBlue Tube 5x1 OD×WT		AdBlue Tube 8x1 OD×WT		AdBlue Tube 8x1 OD×WT	
AH9	6.30-ID4-180°	AH10	6.30-ID4-90°	AH11	6.30-OD5-45°	DU1	6.30 end cap
							
Rubber 4.0 ID		Rubber 4.0 ID		AdBlue Tube 5x1 OD×WT		Applied to 6.30 male end piece	
HT-AB1	6.30-A1 Protection cover	HT-AB2	6.30-A2 Protection cover				
							
适配波纹管外径9.2mm Applied to corrugated pipe with OD of 9.2mm		适配波纹管外径9.2mm Applied to corrugated pipe with OD of 9.2mm					

快速连接器有O型环和工程塑料件组成，我们需要了解规格以及使用环境，正确为您选择合适的连接器。
Connectors are supplied with o-rings and plastic material combinations. To determine correct choices, we must have specification and information on operating conditions.
执行标准：SAE J2044-2009 地面车辆推荐规范-液体燃料和气体排放系统用快速连接规范
Superseding J2044 AUG2009 Quick Connect Coupling Specification for Liquid Fuel and Vapor/Emissions Systems

SAE
7.89-5/16"

7.89燃油快速接头展示
5/16" Fuel Liquid Quick Connectors

B1	7.89-ID6-180°	B2	7.89-ID6-90°	B3	7.89-ID6-180°	B4	7.89-ID6-90°
							
PA 8x1 OD×WT		PA 8x1 OD×WT		PA 8x1 OD×WT		PA 8x1 OD×WT	
B5	7.89-ID7.5-180°	B6	7.89-ID7.5-90°	B7	7.89 T shape 3 Ways	B8	7.89-ID8-180°
							
Rubber 7.5 ID		Rubber 7.5 ID		PA 8x1 OD×T		PA 10x1 OD×WT	
B9	7.89-ID8-90°	B10	7.89 T shape 3 Ways	B11	7.89-ID4-90°	B12	7.89-ID4-180°
							
PA 10x1 OD×WT		PA 8x1 OD×WT and 7.89		PA 6x1 OD×WT		PA 6x1 OD×WT	
B13	7.89-ID6-90°	B14	7.89 T shape 3 Ways	B15	7.89 T shape 3 Ways	B16	7.89-ID6-45°
							
PA 8x1 OD×WT		PA 8x1 OD×WT and 7.89		PA 8x1 OD×WT and 7.89		PA 8x1 OD×WT	

快速连接器有O型环和工程塑料件组成，我们需要了解规格以及使用环境，正确为您选择合适的连接器。
Connectors are supplied with o-rings and plastic material combinations. To determine correct choices, we must have specification and information on operating conditions.
执行标准：SAE J2044-2009 地面车辆推荐规范-液体燃料和气体排放系统用快速连接规范
Superseding J2044 AUG2009 Quick Connect Coupling Specification for Liquid Fuel and Vapor/Emissions Systems

SAE
7.89-5/16"

7.89燃油快速接头展示
5/16" Fuel Liquid Quick Connectors

B17	7.89 T shape 3 Ways	B18	7.89-ID4-180° shut-off valve	B20	7.89-ID6-180°	B21	7.89-ID6-90°
							
PA 8x1	OD×WT	PA 6x1	OD×WT	PA 8x1	OD×WT	Rubber 6.0	ID
B22	7.89-ID5-180°	B23	7.89-ID3-180°	B24	7.89-ID3-90°	B27	7.89-ID6-90°
							
PA 7x1	OD×WT	PA 5x1	OD×WT	PA 5x1	OD×WT	PA 8x1	OD×WT
B28-R	7.89-ID6-90°	B28-L	7.89-ID6-90°	B29	7.89-ID6-180°	B30	7.89-ID5-90°
							
Rubber 6.0	ID	Rubber 6.0	ID	Rubber 6.0	ID	PA 7x1	OD×WT
B31	7.89-ID10-180°	B32	7.89-ID10-90°	B33	7.89-ID7.5-90°	B34	7.89-ID6-65°
							
PA 12.5x1.25	OD×WT	PA 12.5x1.25	OD×WT	Rubber 7.5	ID	PA 8x1	OD×WT

快速连接器有O型环和工程塑料件组成，我们需要了解规格以及使用环境，正确为您选择合适的连接器。
Connectors are supplied with o-rings and plastic material combinations. To determine correct choices, we must have specification and information on operating conditions.
执行标准：SAE J2044-2009 地面车辆推荐规范-液体燃料和气体排放系统用快速连接器
Superseding J2044 AUG2009 Quick Connect Coupling Specification for Liquid Fuel and Vapor/Emissions Systems

SAE
7.89-5/16"

7.89燃油快速接头展示
5/16" Fuel Liquid Quick Connectors

B35	7.89-ID6-90°	B36	7.89-ID6-180° shut-off valve	B37	7.89-ID6-45°	B38	7.89-ID6-180°
							
Rubber 6.0 ID		PA 8x1 OD×WT		Rubber 6.0 ID		Rubber 6.0 ID	
B39	7.89-ID6-30°	B41	7.89-ID8-45°	B42	7.89-等径ID6-90°	B43	7.89-ID4-90°
							
PA 8x1 OD×WT		PA 10x1 OD×WT		PA 8x1 OD×WT		Rubber 4.0 ID	
B44	7.89-ID4-90°	B45	7.89-ID6-90°	B46	7.89-ID6-180°	B50	7.89-ID7.5-45°
							
Rubber 4.0 ID		PA 8x1 OD×WT		PA 8x1 OD×WT		Rubber 7.5 ID	
DB1	7.89 end cap	B52	7.89-ID6-180°	B53	7.89-ID6-90°		
							
Male connector 7.89		PA 8x1 OD×WT		PA 8x1 OD×WT			

快速连接器有O型环和工程塑料件组成，我们需要了解规格以及使用环境，正确为您选择合适的连接器。
Connectors are supplied with o-rings and plastic material combinations. To determine correct choices, we must have specification and information on operating conditions.
执行标准：SAE J2044-2009 地面车辆推荐规范-液体燃料和气体排放系统用快速连接规范
Superseding J2044 AUG2009 Quick Connect Coupling Specification for Liquid Fuel and Vapor/Emissions Systems

SAE
7.89-5/16"

7.89尿素快速接头展示
5/16" SCR Urea Quick Connectors

V1	7.89-ID6-180°	V2	7.89-ID6-90°	V3	7.89-ID6-180°	V4	7.89-ID6-90°
							
AdBlue Tube 8x1 OD×WT		AdBlue Tube 8x1 OD×WT		AdBlue Tube 8x1 OD×WT		AdBlue Tube 8x1 OD×WT	
V5	7.89-ID8-180°	V6	7.89-ID8-90°	V8	7.89-ID3-180°	V9	7.89-ID3-90°
							
AdBlue Tube 10x1 OD×WT		AdBlue Tube 10x1 OD×WT		AdBlue Tube 5x1 OD×WT		AdBlue Tube 5x1 OD×WT	
V13	7.89-ID6-90°	V20	7.89-ID6-180°	V25	7.89-ID6-180°	V26	7.89-ID6-90°
							
AdBlue Tube 8x1 OD×WT		AdBlue Tube 8x1 OD×WT		AdBlue Tube 8x1 OD×WT		AdBlue Tube 8x1 OD×WT	
V27	7.89-ID6-90°	BH1	7.89-OD8-180°	BH2	7.89-OD8-90°	BH3	7.89-OD8-180°
							
AdBlue Tube 8x1 OD×WT		AdBlue Tube 8x1 OD×WT		AdBlue Tube 8x1 OD×WT		AdBlue Tube 8x1 OD×WT	

快速连接器有O型环和工程塑料件组成，我们需要了解规格以及使用环境，正确为您选择合适的连接器。

Connectors are supplied with o-rings and plastic material combinations. To determine correct choices, we must have specification and information on operating conditions.

执行标准：SAE J2044-2009 地面车辆推荐规范-液体燃料和气体排放系统用快速连接规范

Superseding J2044 AUG2009 Quick Connect Coupling Specification for Liquid Fuel and Vapor/Emissions Systems

SAE
7.89-5/16"

7.89尿素快速接头展示
5/16" SCR Urea Quick Connectors

BH4	7.89-OD8-90°	BH5	7.89-OD10-180°	BH6	7.89-OD10-90°	BH7	7.89-ID4-180°
							
AdBlue Tube 8x1 OD×WT		AdBlue Tube 10x1 OD×WT		AdBlue Tube 10x1 OD×WT		AdBlue EPDM 4 ID	
BH8	7.89-ID4-90°	BH9	7.89-OD4-180°	BH10	7.89-OD4-90°	BH11	7.89-OD5-180°
							
AdBlue EPDM 4 ID		AdBlue Tube 4x1 OD×WT		AdBlue Tube 4x1 OD×WT		AdBlue Tube 5x1 OD×WT	
BH12	7.89-OD5-90°	V35	7.89-ID6-90°	V37	7.89-ID6-45°	V38	7.89-ID6-180°
							
AdBlue Tube 5x1 OD×WT		AdBlue EPDM 6.0 ID		AdBlue EPDM 6.0 ID		AdBlue EPDM 6.0 ID	
V43	7.89-ID4-180°	V44	7.89-ID4-90°	V45	7.89-ID6-90°	V46	7.89-ID6-180°
							
AdBlue EPDM 4.0 ID		AdBlue EPDM 4.0 ID		AdBlue Tube 8x1 OD×WT		AdBlue Tube 8x1 OD×WT	

快速连接器有O型环和工程塑料件组成，我们需要了解规格以及使用环境，正确为您推荐合适的连接器。
Connectors are supplied with o-rings and plastic material combinations. To determine correct choices, we must have specification and information on operating conditions.
执行标准：SAE J2044-2009 地面车辆推荐规范-液体燃料和气体排放系统用快速连接规范
Superseding J2044 AUG2009 Quick Connect Coupling Specification for Liquid Fuel and Vapor/Emissions Systems

SAE
7.89-5/16"

7.89尿素快速接头展示
5/16" SCR Urea Quick Connectors

V40 7.89消声器尿素单向阀	V47 7.89消声器尿素单向阀	V48 7.89消声器尿素单向阀	V49 7.89消声器尿素单向阀
			
Customized, not public	Customized, not public	Customized, not public	Customized, not public
AdBlue 7.89 and 9.49 QC	AdBlue 7.89 and 9.49 QC	AdBlue Tube 8x1 OD×WT PDM 4 ID	AdBlue Tube 8x1 OD×WT
V51 7.89消声器尿素单向阀	DV1 7.89 end cap		
			
Customized, not public			
AdBlue Tube 8x1 OD×WT	AdBlue Male connector 7.89		
HT-B1 7.89-B1 Protection cover	HT-B2 7.89-B2 Protection cover	HT-B11 7.89-B12 Protection cover	HT-B12 7.89-B11 Protection cover
			
适配波纹管外径13.0mm Applied to corrugated pipe with OD of 13.0mm	适配波纹管外径13.0mm Applied to corrugated pipe with OD of 13.0mm	适配波纹管外径13.0mm Applied to corrugated pipe with OD of 13.0mm	适配波纹管外径13.0mm Applied to corrugated pipe with OD of 13.0mm
ABT-1 7.89-Straight	ABT-2 7.89-Elbow	ABT-3 7.89-Straight	ABT-4 7.89-Elbow
13J7.89BHG-V3	13E7.89BHG_V0	13Y7.89BHG-V3	13YE7.89BHG-V6
			
Applied to 7.89 straight corrugated pipe	Applied to 7.89 elbow corrugated pipe	Applied to 7.89 straight corrugated pipe with leads	Applied to 7.89 elbow corrugated pipe with leads

快速连接器有O型环和工程塑料件组成，我们需要了解规格以及使用环境，正确为您推荐合适的连接器。
Connectors are supplied with o-rings and plastic material combinations. To determine correct choices, we must have specification and information on operating conditions.
执行标准：SAE J2044-2009 地面车辆推荐规范-液体燃料和气体排放系统用快速连接规范
Superseding J2044 AUG2009 Quick Connect Coupling Specification for Liquid Fuel and Vapor/Emissions Systems

WB1	7.89-ID6-180°	WB2	7.89-ID6-90°	WB8	7.89-ID8-180°	WB9	7.89-ID8-90°
							
PA Tube 8x1 OD×WT		PA Tube 8x1 OD×WT		PA Tube 10x1 OD×WT		PA Tube 10x1 OD×WT	
WB10	7.89 T shape 3 Ways	WB31	7.89-ID10-180°	WB32	7.89-ID10-90°		
							
PA 8x1 OD×WT and 7.89		PA 12.5x1.25 OD×WT		PA 12.5x1.25 OD×WT			

快速连接器有O型环和工程塑料件组成，我们需要了解规格以及使用环境，正确为您推荐合适的连接器。
Connectors are supplied with o-rings and plastic material combinations. To determine correct choices, we must have specification and information on operating conditions.
执行标准：SAE J2044-2009 地面车辆推荐规范-液体燃料和气体排放系统用快速连接规范
Superseding J2044 AUG2009 Quick Connect Coupling Specification for Liquid Fuel and Vapor/Emissions Systems

SAE
9.49-3/8"

9.49 燃油快速接头展示
3/8" Fuel Liquid Quick Connectors

D1	9.49-ID6-180°	D2	9.49-ID6-90°	D3	9.49-ID8-180°	D4	9.49-ID8-90°
PA 8x1 ODxWT		PA 8x1 ODxWT		PA 10x1 ODxWT		PA 10x1 ODxWT	
D5	9.49-ID6-90°	D6	9.49-ID7.5-180°	D7	9.49-ID7.5-90°	D8	9.49-ID9.5-180°
PA 8x1 ODxWT		Rubber 7.5 ID		Rubber 7.5 ID		Rubber 9.5 ID	
D9	9.49-ID4-180°	D10	9.49-ID4-90°	D11	9.49-ID9.5-90°	D13	9.49-ID8-90°
PA 6x1 ODxWT		PA 6x1 ODxWT		Rubber 9.5 ID		PA 10x1 ODxWT	
D14	9.49-ID12-180°	D15	9.49-ID12-90°	D16	9.49-ID14-180°	D17	9.49-ID14-90°
PA 15x1.5 ODxWT		PA 15x1.5 ODxWT		PA 18x2.0 ODxWT		PA 18x2.0 ODxWT	

快速连接器有O型环和工程塑料件组成，我们需要了解规格以及使用环境，正确为您推荐合适的连接器。











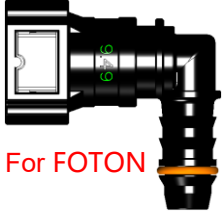

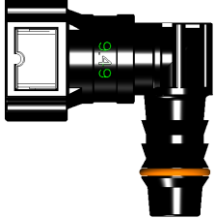
Connectors are supplied with o-rings and plastic material combinations. To determine correct choices, we must have specification and information on operating conditions.

执行标准：SAE J2044-2009 地面车辆推荐规范-液体燃料和气体排放系统用快速连接规范

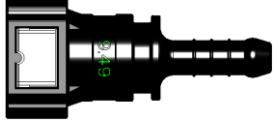
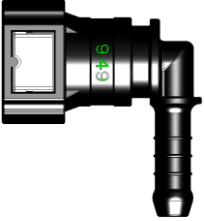
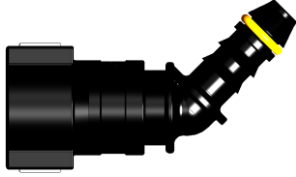
Superseding J2044 AUG2009 Quick Connect Coupling Specification for Liquid Fuel and Vapor/Emissions Systems

SAE
9.49-3/8"

9.49 燃油快速接头展示
3/8" Fuel Liquid Quick Connectors

D18	9.49-ID8-180°	D19	9.49-ID8-90°	D20	9.49-ID10-180°	D21	9.49-ID10-90°
	For FOTON		For FOTON				
PA 10x1	OD×WT	PA 10x1	OD×WT	PA 12.5x1.25	OD×WT	PA 12.5x1.25	OD×WT
D22	9.49-ID7.5-45°	D23	9.49-ID3-180°	D24	9.49-ID3-90°	D25	9.49-ID6-180°
							
Rubber 7.5	ID	PA 5x1	OD×WT	PA 5x1	OD×WT	Rubber 6.0	ID
D26	9.49-ID6-90°	D27	9.49-ID6-45°	D28	9.49-ID12-180°	D29	9.49-ID12-90°
							
Rubber 6.0	ID	PA 8x1	OD×T	PA 15x1.5	OD×WT	PA 15x1.5	OD×WT
D34	9.49-ID11-180°	D35	9.49-ID11-90°	D7-S	9.49-ID9.5-90°	D8-S	9.49-ID9.0-0°
							
PA 14x1.5	OD×WT	PA 14x1.5	OD×WT	Rubber 9.5	ID	Rubber 9.0	ID

快速连接器有O型环和工程塑料件组成，我们需要了解规格以及使用环境，正确为您选择合适的连接器。
Connectors are supplied with o-rings and plastic material combinations. To determine correct choices, we must have specification and information on operating conditions.
执行标准：SAE J2044-2009 地面车辆推荐规范-液体燃料和气体排放系统用快速连接规范
Superseding J2044 AUG2009 Quick Connect Coupling Specification for Liquid Fuel and Vapor/Emissions Systems

SAE
9.49-3/8"

9.49尿素快速接头展示
3/8" SCR Urea Quick Connectors





X1	9.49-ID6-180°	X2	9.49-ID6-90°	X3	9.49-ID8-180°	X4	9.49-ID8-90°
							
AdBlue Tube 8x1 OD×WT		AdBlue Tube 8x1 OD×WT		AdBlue Tube 10x1 OD×WT		AdBlue Tube 10x1 OD×WT	
X5	7.89-ID4-180°	X6	7.89-ID4-90°	X23	7.89-ID3-180°	X24	7.89-ID3-90°
							
AdBlue Tube 6x1 OD×WT		AdBlue Tube 6x1 OD×WT		AdBlue Tube 5x1 OD×WT		AdBlue Tube 5x1 OD×WT	
X25	7.89-ID6-180°	X26	7.89-ID6-90°				
							
AdBlue EPDM 6 ID		AdBlue EPDM 6 ID					
HT-D1	9.49-D1 Protection cover	HT-D2	9.49-D2 Protection cover	HT-D9	9.49-D9 Protection cover	HT-D10	9.49-D10 Protection cover
							
适配波纹管外径13.0mm Applied to corrugated pipe with OD of 13.0mm		适配波纹管外径13.0mm Applied to corrugated pipe with OD of 13.0mm		适配波纹管外径9.2mm Applied to corrugated pipe with OD of 9.2mm		适配波纹管外径9.2mm Applied to corrugated pipe with OD of 9.2mm	

快速连接器有O型环和工程塑料件组成，我们需要了解规格以及使用环境，正确为您选择合适的连接器。
Connectors are supplied with o-rings and plastic material combinations. To determine correct choices, we must have specification and information on operating conditions.
执行标准：SAE J2044-2009 地面车辆推荐规范-液体燃料和气体排放系统用快速连接规范
Superseding J2044 AUG2009 Quick Connect Coupling Specification for Liquid Fuel and Vapor/Emissions Systems

DH1 9.49-OD8-180°	DH2 9.49-OD8-90°	DH3 9.49-OD8-180°	DH4 9.49-OD8-90°
			
AdBlue Tube 8x1 OD×WT	AdBlue Tube 8x1 OD×WT	AdBlue Tube 8x1 OD×WT	AdBlue Tube 8x1 OD×WT
DH5 9.49-OD10-180°	DH6 9.49-OD10-90°	DH7 9.49-ID6-180°	DH8 9.49-ID6-90°
			
AdBlue Tube 10x1 OD×WT	AdBlue Tube 10x1 OD×WT	AdBlue Tube 8x1 OD×WT	AdBlue Tube 8x1 OD×WT
DH9 7.89-ID4-180°	DH10 7.89-ID4-90°	DH11 9.49-OD5-180°	DH12 9.49-OD4-180°
			
AdBlue EPDM 4 ID	AdBlue EPDM 4 ID	AdBlue Tube 5x1 OD×WT	AdBlue Tube 4x1 OD×WT
DH13 9.49-OD4-90°	DH14 9.49-OD5-180°	DH15 9.49-OD5-90°	DX1 9.49 end cap
			
AdBlue Tube 4x1 OD×WT	AdBlue Tube 5x1 OD×WT	AdBlue Tube 5x1 OD×WT	AdBlue Male connector 9.49



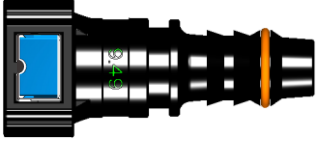
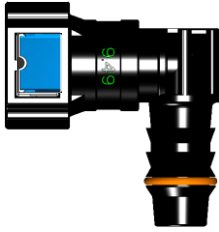
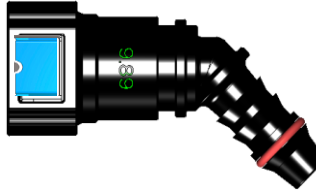
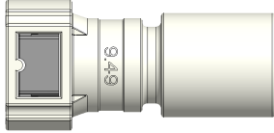
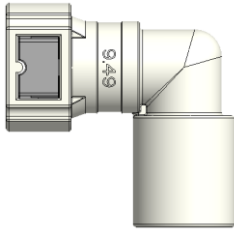
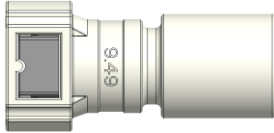
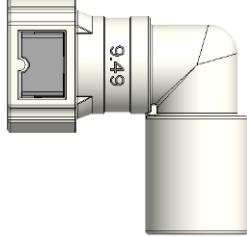

SAE
9.49-3/8"

9.49液冷快速接头展示
3/8" Cooling systems Quick Connectors

WD1 9.49-ID6-180°	WD2 9.49-ID6-90°	WD3 9.49-ID8-180°	WD4 9.49-ID8-90°
			
PA Tube 8x1 OD×WT	PA Tube 8x1 OD×WT	PA Tube 10x1 OD×WT	PA Tube 10x1 OD×WT
WD20 9.49-ID10-180°	WD21 9.49-ID10-90°		WE11 9.89-ID8-45°
			
PA 12.5x1.25 OD×WT	PA 12.5x1.25 OD×WT		PA 10x1 OD×WT
WD30 9.49-OD15.5-180°	WD31 9.49-OD15.5-90°	WD32 9.49-OD14.8-180°	WD33 9.49-OD14.8-90°
			
PA Tube 15.5 (OD 外径)	PA Tube 15.5 (OD 外径)	PA Tube 14.8 (OD 外径)	PA Tube 14.8 (OD 外径)

SAE
9.89

9.89液冷快速接头展示
9.89 Cooling systems Quick Connectors

WE1 9.89-ID8-180°	WE2 9.89-ID8-90°	WE8 9.89-ID10-180°	WE4 9.89-ID10-90°
			
PA 10x1 OD×WT	PA 10x1 OD×WT	PA 12.5x1.25 OD×WT	PA 12.5x1.25 OD×WT





快速连接器有O型环和工程塑料件组成，我们需要了解规格以及使用环境，正确为您推荐合适的连接器。
Connectors are supplied with o-rings and plastic material combinations. To determine correct choices, we must have specification and information on operating conditions.
执行标准：SAE J2044-2009 地面车辆推荐规范-液体燃料和气体排放系统用快速连接规范
Superseding J2044 AUG2009 Quick Connect Coupling Specification for Liquid Fuel and Vapor/Emissions Systems

E1	9.89-ID8-180°	E2	9.89-ID8-90°	E3	9.89-ID9-180°	E4	9.89-ID10-90°
							
PA 10x1 OD×WT	PA 10x1 OD×WT	PA 12x1.5 OD×WT	PA 12.5x1.25 OD×WT				
E5	9.89-ID9.5-90°	E6	9.89-ID6-180°	E7	9.89-ID7.5-180°	E8	9.89-ID10-180°
							
Rubber 9.5 ID	PA 8x1 OD×T	Rubber 7.5 ID	PA 12.5x1.25 OD×WT				
E9	9.89-ID6-90°	E10	9.89-9.89-C	E11	9.89-ID8-45°	E12	9.89-ID9.5-180°
	 可快速连接传感器的快速接头						
PA 8x1 OD×WT	Applied to 9.89 QC	PA 10x1 OD×WT	Rubber 9.5 ID				
E13	9.89-ID6-45°	E18	9.89-ID8-180°	E19	9.89-ID8-90°	E23	10.0-ID6-180°
	 不可拆卸接头 Non-detachable	 不可拆卸接头 Non-detachable					
PA 8X1 OD×WT	PA 10x1.0 OD×WT	PA 10x1.0 OD×WT	PA 8X1 OD×WT				

G1	11.80-ID10-180°	G2	11.80-ID10-90°	G3	11.8-ID12-180°	G4	11.80-ID9-180°
							
PA 12.5x1.25 OD×WT		PA 12.5x1.25 OD×WT		PA 15x1.5 OD×WT		PA 12.0x1.5 OD×WT	
G5	11.80-ID9-90°	G6	11.80-ID10-45°	G7	11.80-ID14-180°	G8	11.80-ID8-180°
							
PA 12.0x1.5 OD×WT		PA 12.5x1.25 OD×WT		PA 18.0x2.0 OD×WT		PA 10x1.0 OD×WT	
G9	11.80-ID8-90°	G10	11.8-ID12-180°	G11	11.8-ID12-90°	G12	11.8-ID12-45°
							
PA 10x1.0 OD×WT		PA 15x1.5 OD×WT		PA 15x1.5 OD×WT		PA 15x1.5 OD×WT	
G13	11.8-ID8-45°	DG1	11.8 end cap	G14	11.8-ID10		
							
PA 10X1 OD×WT		Male connector 11.80		SAE7.89 & PA 12.5x1.25 OD×WT			



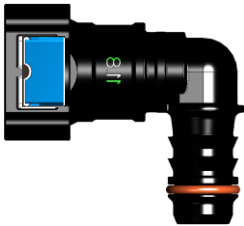
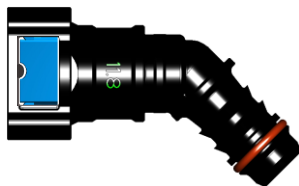

**SAE
11.80**

**11.80 液冷快速接头展示
11.80 Cooling system Quick Connectors**

WG1	11.8-ID10-180°	WG2	11.8-ID10-180°	WG6	11.8-ID10-45°	WG10	11.8-ID12-180°
							
PA 12.5x1.25 OD×WT		PA 12.5x1.25 OD×WT		PA 12.5x1.25 OD×WT		PA 15x1.5 OD×WT	
WG11	11.8-ID12-90°	WG12	11.8-ID12-45°				
							
PA 15x1.5 OD×WT		PA 15x1.5 OD×WT					

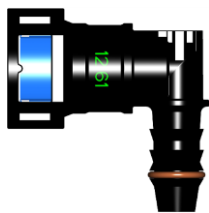
**SAE
12.61-1/2"**

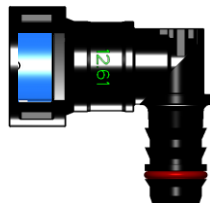









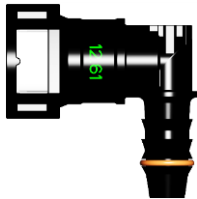

**12.61 液冷快速接头展示
12.61 Cooling systems Quick Connectors**

WJ5	12.61-ID10-180°	WJ6	12.61-ID10-90°	WJ11	12.61-ID12-180°	WJ12	12.61-ID12-90°
							
PA 12.5x1.25 OD×WT		PA 12.5x1.25 OD×WT		PA 15x1.5 OD×WT		PA 15x1.5 OD×WT	
WJ17	12.61-ID14-180°	WJ18	12.61-ID14-90°				
							
PA 17x1.5 OD×WT		PA 17x1.5 OD×WT					

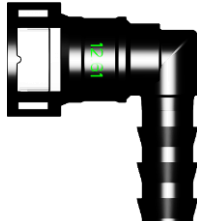
快速连接器有O型环和工程塑料件组成，我们需要了解规格以及使用环境，正确为您选择合适的连接器。
Connectors are supplied with o-rings and plastic material combinations. To determine correct choices, we must have specification and information on operating conditions.
执行标准：SAE J2044-2009 地面车辆推荐规范-液体燃料和气体排放系统用快速连接规范
Superseding J2044 AUG2009 Quick Connect Coupling Specification for Liquid Fuel and Vapor/Emissions Systems

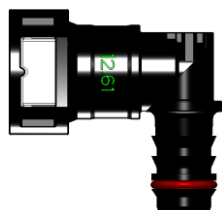
SAE
12.61 1/2"

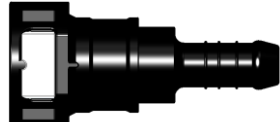
12.61 燃油快速接头展示
1/2" Fuel Liquid Quick Connectors

J1	12.61-ID12-180°	J2	12.61-ID12-90°	J3	12.61-ID12-180°	J4	12.61-ID12-90°
							
PA 15x1.5 OD×WT		PA 15x1.5 OD×WT		PA 15x1.5 OD×WT		PA 15x1.5 OD×WT	
J5	12.61-ID9/10-180°	J6	12.61-ID9/10-90°	J7	12.61-ID6-180°	J8	12.61-ID14-180°
							
PA 12.0x1.5 OD×WT		PA 12.0x1.5 OD×WT		PA 8.0x1.0 OD×WT		PA 18x2 OD×WT	
J9	12.61-ID14-90°	J11	12.61-ID12-180°	J12	12.61-ID12-90°	J13	12.61-ID9.5-90°
							
PA 18x2 OD×WT		PA 15x1.5 OD×WT		PA 15x1.5 OD×WT		Rubber 9.5 ID	
J14	12.61-ID9.5-180°	J15	12.61-ID8-180°	J16	12.61-ID8-90°		
							
Rubber 9.5 ID		PA 10x1.0 OD×WT		PA 10x1.0 OD×WT			

快速连接器有O型环和工程塑料件组成，我们需要了解规格以及使用环境，正确为您推荐合适的连接器。













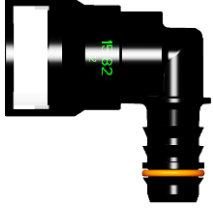

Connectors are supplied with o-rings and plastic material combinations. To determine correct choices, we must have specification and information on operating conditions.

执行标准：SAE J2044-2009 地面车辆推荐规范-液体燃料和气体排放系统用快速连接规范

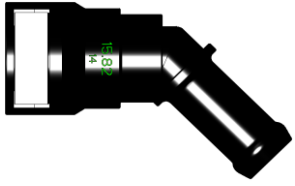
Superseding J2044 AUG2009 Quick Connect Coupling Specification for Liquid Fuel and Vapor/Emissions Systems

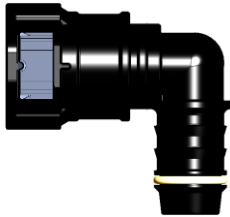
SAE
15.82-5/8"

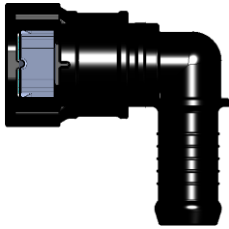
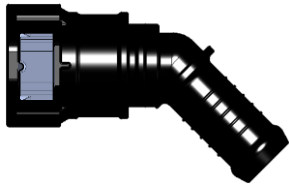
15.82 燃油快速接头展示
5/8" Fuel Liquid Quick Connectors

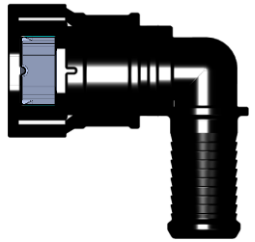
H1	15.82-ID14-90°	H2	15.82-ID14-180°	H3	15.82-ID14-180°	H4	15.82-ID12-180°
							
PA 17x1.5 ODxWT		PA 17x1.5 ODxWT		Rubber 14.0 ID		PA 15.0x1.5 ODxWT	
H5	15.82-ID12-90°	H6	15.82-ID14-45°	H7-R	15.82-ID14-90°	H7-L	15.82-ID14-90°
							
PA 15.0x1.5 ODxWT		PA 17.0x1.5 ODxWT		Rubber 14.0 ID		Rubber 14.0 ID	
H8	15.82-ID14-45°	H9	15.82-ID14-180°	H10	15.82-ID14-90°	H11	15.82-ID14-180°
							
Rubber 14.0 ID		PA 17x1.5 ODxWT		PA 17x1.5 ODxWT		Rubber 14.0 ID	
H12	15.82-ID14-90°	H13	15.82-ID14-45°	H14	15.82-ID15-180°	H15	15.82-ID14-90°
							
Rubber 14.0 ID		Rubber 14.0 ID		PA 18x1.5 ODxWT		Rubber 14.0 ID	

快速连接器有O型环和工程塑料件组成，我们需要了解规格以及使用环境，正确为您推荐合适的连接器。

Connectors are supplied with o-rings and plastic material combinations. To determine correct choices, we must have specification and information on operating conditions.

执行标准：SAE J2044-2009 地面车辆推荐规范-液体燃料和气体排放系统用快速连接规范

Superseding J2044 AUG2009 Quick Connect Coupling Specification for Liquid Fuel and Vapor/Emissions Systems

SAE
15.82-5/8"









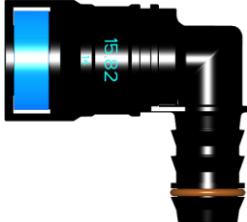

15.82 燃油快速接头展示
5/8" Fuel Liquid Quick Connectors

H16	15.82-ID14-45°	H17	15.82-ID12-180°	H18	15.82-ID12-90°	H19	15.82-ID12-45°
PA 17x1.5 ODxWT		PA 15.0x1.5 ODxWT		PA 15.0x1.5 ODxWT		PA 15.0x1.5 ODxWT	
H20	15.82-OD17.5	H21	15.82-OD17.5	H22	15.82-ID10-180°	H23	15.82-ID10-90°
PA 17.5 OD		PA 17.5 OD		PA 12.5x1.25 ODxWT		PA 12.5x1.25 ODxWT	
H-cap	15.82 end cap	H-DN6	15.82-ID15-DN6	H24	15.82-ID16-180°	H25	15.82-ID16-90°
		Rubber 15.0 ID and DN6		PA 19x1.5 ODxWT		PA 19x1.5 ODxWT	
H26	15.82-ID14-180°	H27	15.82-ID16-180°	H28	15.82-ID16-90°	H29	15.82-ID16-45°
PA 17x1.5 ODXWT		Rubber 16.0 ID		Rubber 16.0 ID		Rubber 16.0 ID	

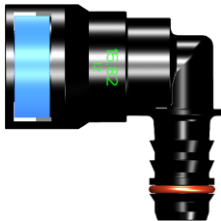
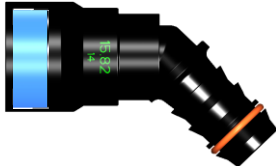
快速连接器有O型环和工程塑料件组成，我们需要了解规格以及使用环境，正确为您推荐合适的连接器。
Connectors are supplied with o-rings and plastic material combinations. To determine correct choices, we must have specification and information on operating conditions.
执行标准：SAE J2044-2009 地面车辆推荐规范-液体燃料和气体排放系统用快速连接规范
Superseding J2044 AUG2009 Quick Connect Coupling Specification for Liquid Fuel and Vapor/Emissions Systems

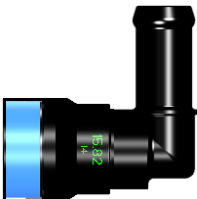
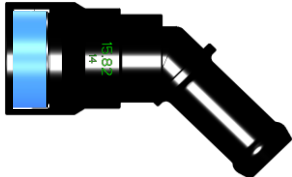
SAE
15.82-5/8"

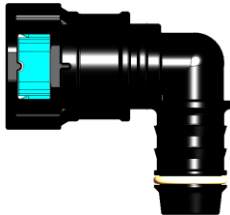
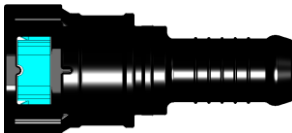
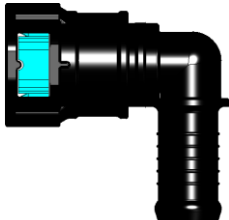
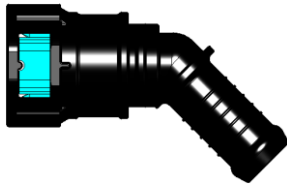
15.82 液冷快速接头展示
15.82 Cooling system Quick Connectors

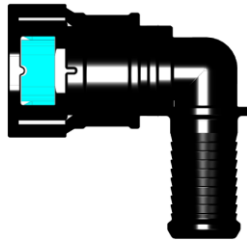
WH1	15.82-ID14-90°	WH2	15.82-ID14-180°	WH3	15.82-ID14-180°	WH4	15.82-ID12-180°
							
PA 17x1.5 ODxWT		PA 17x1.5 ODxWT		Rubber 14.0 ID		PA 15.0x1.5 ODxWT	
WH5	15.82-ID12-90°	WH6	15.82-ID14-45°	WH7-R	15.82-ID14-90°	WH7-L	15.82-ID14-90°
							
PA 15.0x1.5 ODxWT		PA 17.0x1.5 ODxWT		Rubber 14.0 ID		Rubber 14.0 ID	
WH8	15.82-ID14-45°	WH9	15.82-ID14-180°	WH10	15.82-ID14-90°	WH11	15.82-ID14-180°
							
Rubber 14.0 ID		PA 17x1.5 ODxWT		PA 17x1.5 ODxWT		Rubber 14.0 ID	
WH12	15.82-ID14-90°	WH13	15.82-ID14-45°	WH14	15.82-ID15-180°	WH15	15.82-ID14-90°
							
Rubber 14.0 ID		Rubber 14.0 ID		PA 18x1.5 ODxWT		Rubber 14.0 ID	

快速连接器有O型环和工程塑料件组成，我们需要了解规格以及使用环境，正确为您推荐合适的连接器。

Connectors are supplied with o-rings and plastic material combinations. To determine correct choices, we must have specification and information on operating conditions.

执行标准：SAE J2044-2009 地面车辆推荐规范-液体燃料和气体排放系统用快速连接规范

Superseding J2044 AUG2009 Quick Connect Coupling Specification for Liquid Fuel and Vapor/Emissions Systems

SAE
15.82-5/8"

15.82 液冷快速接头展示
15.82 Cooling system Quick Connectors

WH16	15.82-ID14-45°	WH17	15.82-ID12-180°	WH18	15.82-ID12-90°	WH19	15.82-ID12-45°
							
PA 17x1.5 OD×WT		PA 15.0x1.5 OD×WT		PA 15.0x1.5 OD×WT		PA 15.0x1.5 OD×WT	
WH20	15.82-OD17.5	WH21	15.82-OD17.5	WH22	15.82-ID10-180°	WH23	15.82-ID10-90°
							
PA 17.5 OD		PA 17.5 OD		PA 12.5x1.25 OD×WT		PA 12.5x1.25 OD×WT	
WH24	15.82-ID16-180°	WH25	15.82-ID16-90°				
							
PA 19x1.5 OD×WT		PA 19x1.5 OD×WT					

SAE
17.5

17.5 燃油快速接头展示

17.5 Fuel Liquid Quick Connectors

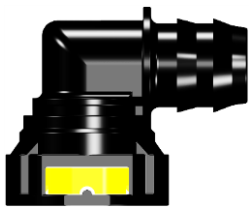
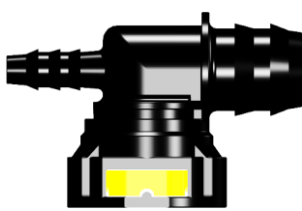
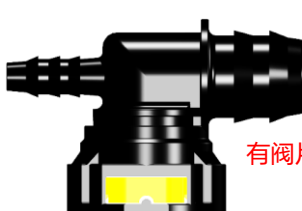
K1	17.5-ID15-180°	K2	17.5-ID15-90°	K3	17.5-T-3Ways	K4	17.5-T-3Ways
							有阀片
PA 18x1.5 OD×WT		PA 18x1.5 OD×WT		PA 18x1.5 /8x1 OD×WT		PA 18x1.5 /8x1 OD×WT	

K5
17.5-ID16-180°



PA 19.5x1.5 OD×WT

SAE
18.0

18.0 燃油快速接头展示

18.0 Fuel Liquid Quick Connectors

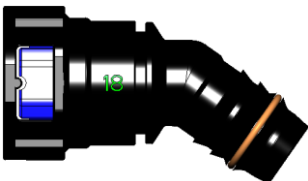
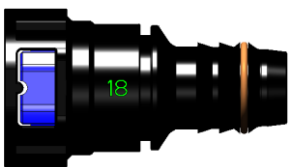
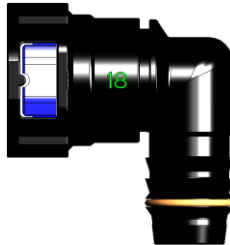
P1	18.0-ID15-35°	P2	18.0-ID15-180°	P3	18.0-ID15-90°		
							
PA 18x1.5 OD×WT		PA 18x1.5 OD×WT		PA 18x1.5 OD×WT			

SAE
18.9

18.9 燃油快速接头展示

18.9 Fuel Liquid Quick Connectors

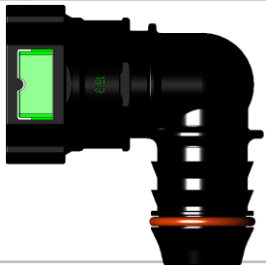
Q1	18.9-ID16.5-180°	Q2	18.9-ID16.5-90°				
							
PA 19.5x1.5 OD×WT		PA 19.5x1.5 OD×WT					

快速连接器有O型环和工程塑料件组成，我们需要了解规格以及使用环境，正确为您选择合适的连接器。

Connectors are supplied with o-rings and plastic material combinations. To determine correct choices, we must have specification and information on operating conditions.

执行标准：SAE J2044-2009 地面车辆推荐规范-液体燃料和气体排放系统用快速连接规范

Superseding J2044 AUG2009 Quick Connect Coupling Specification for Liquid Fuel and Vapor/Emissions Systems

SAE
18.0

18.0 液冷快速接头展示

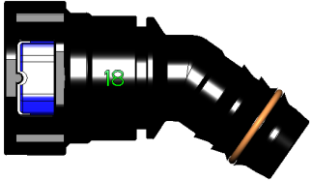
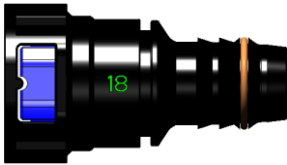
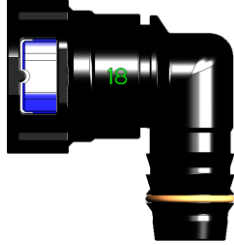

18.0 Cooling system Quick Connectors

WP1	18.0-ID15-35°	WP2	18.0-ID15-180°	WP3	18.0-ID15-90°		
							
PA 18x1.5 OD×WT		PA 18x1.5 OD×WT		PA 18x1.5 OD×WT			

SAE
18.9

18.9 液冷快速接头展示

18.9 Cooling systems Quick Connectors

WQ1	18.9-ID16.5	WQ2	18.9-ID16.5		
					
PA 19.5x1.5 OD×WT		PA 19.5x1.5 OD×WT			

SAE
24.0

24.0 液冷快速接头展示

24.0 Cooling systems Quick Connectors

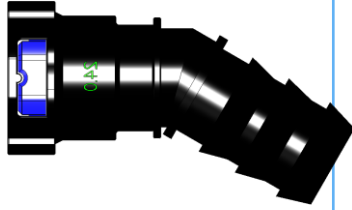
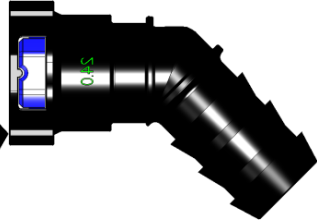
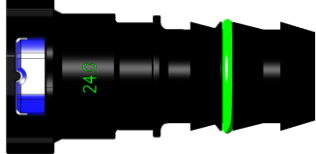
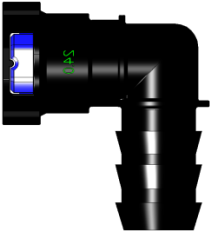
WN1	24.0-ID21	WN2	24.0-ID21-30°	WN3	24.0-ID21-45°	WN4	24.0-ID21
							
PA 25x2 OD×WT		PA 25x2 OD×WT		PA 25x2 OD×WT		PA 25x2 OD×T	
WN5	24.0-ID21-90°						
							
PA 25x2 OD×WT							

**SAE
24.0**

24.0 燃油快速接头展示
24.0 Fuel Liquid Quick Connectors

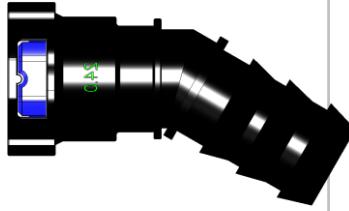
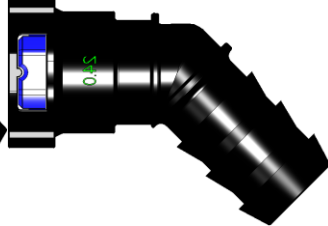
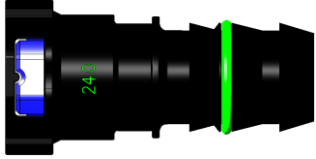
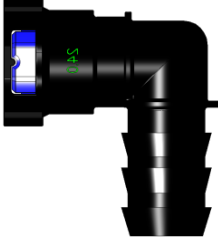
N1	24.0-ID21-180°	N2	24.0-ID21-30°	N3	24.0-ID21-45°	N4	24.0-ID21-180°
							
PA 25x2 ODxWT		PA 25x2 ODxWT		PA 25x2 ODxWT		PA 25x2 ODxWT	
N5	24.0-ID21-90°						
							
PA 25x2 ODxWT							

**Safe
Lock**

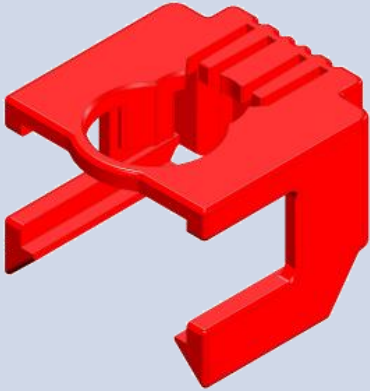

快速接头安全锁展示
SAEEQC Double safe Lock

Photo	Item No.	Application	Color
	SDL1	6.30 QC	NA
	SDL2	7.89 QC	NA
	SDL3	9.49 QC	NA
	SDL4	9.89 QC	NA
	SDL5	11.8 QC	NA

快速连接器有O型环和工程塑料件组成，我们需要了解规格以及使用环境，正确为您推荐合适的连接器。
Connectors are supplied with o-rings and plastic material combinations. To determine correct choices, we must have specification and information on operating conditions.
执行标准：SAE J2044-2009 地面车辆推荐规范-液体燃料和气体排放系统用快速连接规范
Superseding J2044 AUG2009 Quick Connect Coupling Specification for Liquid Fuel and Vapor/Emissions Systems

SAE END Piece

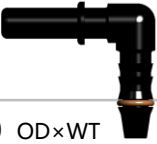
快速接头阳接头展示 Quick connectors end piece

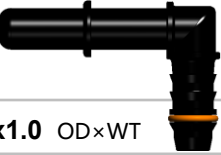
MEP1	6.30-ID6	MEP22	6.30-ID6		
					
PA 8.0x1.0	OD×WT	PA 8.0x1.0	OD×WT		
MEP2	7.89-ID6	MEP3	7.89-ID6	MEP4	7.89-ID6
					
PA 8.0x1.0	OD×WT	PA 8.0x1.0	OD×WT	PA 8.0x1.0	OD×WT
MEP14	7.89-ID4	MEP15	7.89-ID6	MEP30	7.89-ID6
					
PA 6.0x1.0	OD×WT	PA 8.0x1.0	OD×WT	PA 8.0x1.0	OD×WT
MEP32	7.89-ID6	MEP33	7.89-ID6	MEP34	7.89-ID6
					
PA 8.0x1.0	OD×WT	PA 8.0x1.0	OD×WT	PA 8.0x1.0	OD×WT
MEP6	9.49-ID6	MEP7	9.49-ID8	MEP11	9.49-ID6
					
PA 8.0x1.0	OD×WT	PA 10.0x1.0	OD×WT	PA 8.0x1.0	OD×WT
MEP20	9.49-ID10	MEP26	9.49-ID8	MEP37	8.0-ID6
					
PA 12.5x1.25	OD×WT	PA 10.0x1.0	OD×WT	PA 8.0x1.0	OD×WT
MEP8	9.89-ID8	MEP9	9.89-ID8	MEP16	9.89-ID6
					
PA 10.0x1.0	OD×WT	PA 10.0x1.0	OD×WT	PA 8.0x1.0	OD×WT
MEP29	10.0-ID8				
					
PA 10x1	OD×WT				

快速连接器有O型环和工程塑料件组成，我们需要了解规格以及使用环境，正确为您推荐合适的连接器。









Connectors are supplied with o-rings and plastic material combinations. To determine correct choices, we must have specification and information on operating conditions.

执行标准：SAE J2044-2009 地面车辆推荐规范-液体燃料和气体排放系统用快速连接规范

Superseding J2044 AUG2009 Quick Connect Coupling Specification for Liquid Fuel and Vapor/Emissions Systems

**SAE
END Piece**

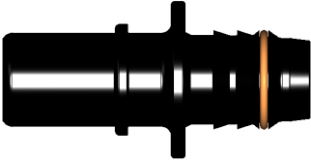

**快速接头阳接头展示
Quick connectors end piece**

MEP10	11.80-ID10						
							
PA 12.5x1.25 ODxWT							
MEP17	12.61-ID10	MEP25	12.61-ID12				
							
PA 12.5x1.25 ODxWT		PA 15.0x1.5 ODxWT					
MEP13	15.82-ID14	MEP18	15.82-ID12	MEP19	15.82-ID15.5	MEP24	15.82-ID12
							
PA 17.0x1.5 ODxWT		PA 15.0x1.5 ODxWT		Rubber 15.5 ID		PA 15.0x1.5 ODxWT	
MEP28	15.82-ID15						
							
PA 18.0x1.5 ODxWT							
MEP27	18.0-ID15						
							
PA 18.0x1.5 ODxWT							

快速连接器有O型环和工程塑料件组成，我们需要了解规格以及使用环境，正确为您推荐合适的连接器。
Connectors are supplied with o-rings and plastic material combinations. To determine correct choices, we must have specification and information on operating conditions.
执行标准：SAE J2044-2009 地面车辆推荐规范-液体燃料和气体排放系统用快速连接规范
Superseding J2044 AUG2009 Quick Connect Coupling Specification for Liquid Fuel and Vapor/Emissions Systems

VDA NW6/NW8



Steel wire lock Quick connector Show

GA1	NW6-ID6	GA2	NW6-ID6-L	GA3	NW6-ID6-41.5°	GA4	NW6-ID6 male end
							
PA 6.0 ID		PA 6.0 ID		PA 6.0 ID		PA 6.0 ID	
GA5	NW6-ID10	GA6	NW6-ID10-L	GA7	NW6-ID10-41.5°		
							
Rubber 10.0 ID		Rubber 10.0 ID		Rubber 10.0 ID			
HA1	NW8-ID6	HA2	NW8-ID6-L	HA3	NW8-ID6-45°	HA4	NW8-ID8
PA 6.0 ID		PA 6.0 ID		PA 6.0 ID		PA 8.0 ID	
HA5	NW8-ID8-L	HA6	NW8-ID8-45°	HA7	NW8-ID8	HA8	NW8-ID8-L
PA 8.0 ID		PA 8.0 ID		Rubber 8.0 ID		Rubber 8.0 ID	

快速连接器有O型环和工程塑料件组成，我们需要了解规格以及使用环境，正确为您推荐合适的连接器。
 Connectors are supplied with o-rings and plastic material combinations. To determine correct choices, we must have specification and information on operating conditions.
 执行标准：SAE J2044-2009 地面车辆推荐规范-液体燃料和气体排放系统用快速连接规范
 Superseding J2044 AUG2009 Quick Connect Coupling Specification for Liquid Fuel and Vapor/Emissions Systems

VDA NW6/NW8

Steel wire lock Quick connector Show

HA9	NW8-ID8-45°	HA10	NW8-ID14-180°	HA11	NW8-ID14-90°		
							
	Rubber 8.0 ID	PA 14.0 ID		PA 14.0 ID			

快速连接器有O型环和工程塑料件组成，我们需要了解规格以及使用环境，正确为您选择合适的连接器。



Connectors are supplied with o-rings and plastic material combinations. To determine correct choices, we must have specification and information on operating conditions.

执行标准：SAE J2044-2009 地面车辆推荐规范-液体燃料和气体排放系统用快速连接规范

Superseding J2044 AUG2009 Quick Connect Coupling Specification for Liquid Fuel and Vapor/Emissions Systems

VDA NW12

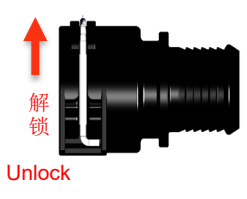
Steel wire lock Quick connector Show

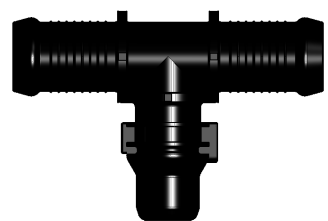
JA1	NW12-ID18	JA2	NW12-ID18	JA3	NW12-ID18-45°	JA4	NW12-ID18 T
							
Rubber 18.0 ID		Rubber 18.0 ID		Rubber 18.0 ID		Rubber 18.0 ID	
JA5	NW12-ID14	JA6	NW12-ID14				
							
PA 14.0 ID		PA 14.0 ID					

NSC 12钢丝扣快速接头展示







Steel wire lock Quick connector Show

NSC-1	NSC12-10-0°	NSC-2	NSC12-12-0°	NSC-3	NSC12-10-90°	NSC-4	NSC12-10-0°
							
Rb 10.0 ID		Rb 12.0 ID		Rb 10.0 ID		Rb 10.0 ID	

快速连接器有O型环和工程塑料件组成，我们需要了解规格以及使用环境，正确为您推荐合适的连接器。
 Connectors are supplied with o-rings and plastic material combinations. To determine correct choices, we must have specification and information on operating conditions.
 执行标准：SAE J2044-2009 地面车辆推荐规范-液体燃料和气体排放系统用快速连接规范
 Superseding J2044 AUG2009 Quick Connect Coupling Specification for Liquid Fuel and Vapor/Emissions Systems

VDA NW16

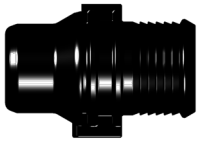
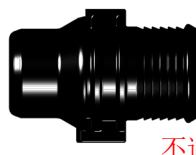
Steel wire lock Quick connector Show

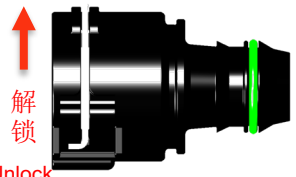
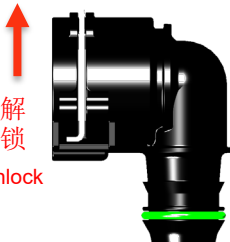
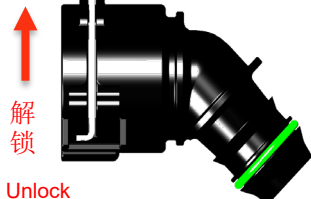
NB1	NW16-ID22	NB2	NW16-ID22	NB3	NW16-ID22-45°	NB4	NW16-ID22-45°
							
解锁 Unlock		解锁 Unlock		解锁 Unlock		解锁 Unlock	
Rubber 22.0 ID		Rubber 22.0 ID		Rubber 22.0 ID		Rubber 22.0 ID	
NB5	NW16-ID22-T	NB6	NW16-ID22	NB6-D	NW16 end cap	NB1-D	NW16 end cap
							
				不通孔 Blocked		解锁 Unlock	不通孔 Blocked
Rubber 22.0 ID		Rubber 22.0 ID		NW16 QC		NW16 QC	
NB7	NW16-ID16	NB8	NW16-ID16	NB9	NW16-ID16-45°		
							
解锁 Unlock		解锁 Unlock		解锁 Unlock			
PA 19x1.5 ODxWT		PA 19x1.5 ODxWT		PA 19x1.5 ODxWT			

快速连接器有O型环和工程塑料件组成，我们需要了解规格以及使用环境，正确为您推荐合适的连接器。



Connectors are supplied with o-rings and plastic material combinations. To determine correct choices, we must have specification and information on operating conditions.

执行标准：SAE J2044-2009 地面车辆推荐规范-液体燃料和气体排放系统用快速连接规范

Superseding J2044 AUG2009 Quick Connect Coupling Specification for Liquid Fuel and Vapor/Emissions Systems

VDA NW18

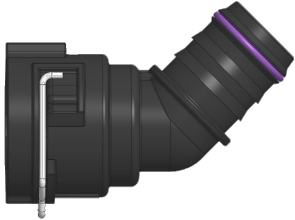
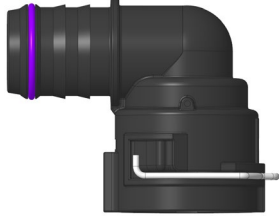
Steel wire lock Quick connector Show

PB1	NW18-ID18	PB2	NW18-ID18-60°	PB3	NW18-ID18-90°	PB5	NW18-ID18
							
PA 17.0 ID		PA 17.0 ID		PA 17.0 ID		PA 17.0 ID	

快速连接器有O型环和工程塑料件组成，我们需要了解规格以及使用环境，正确为您推荐合适的连接器。
 Connectors are supplied with o' rings and plastic material combinations. To determine correct choices, we must have specification and information on operating conditions.
 执行标准：SAE J2044-2009 地面车辆推荐规范-液体燃料和气体排放系统用快速连接规范
 Superseding J2044 AUG2009 Quick Connect Coupling Specification for Liquid Fuel and Vapor/Emissions Systems



VDA NW22

Steel wire lock Quick connector Show

XB5	NW22-ID25	XB6	NW22-ID25	XB7	NW22-ID25		
							
PA 29x2.0 ODxWT		PA 29x2.0 ODxWT		PA 29x2.0 ODxWT			

VDA NW26

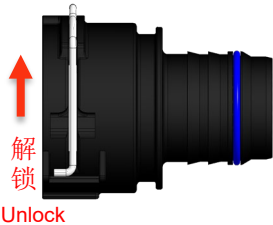
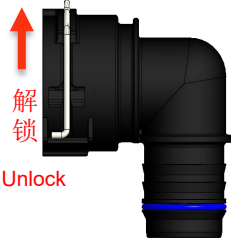
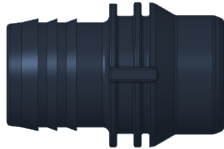
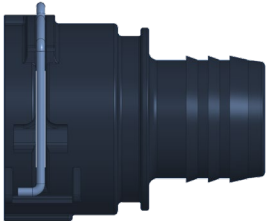
Steel wire lock Quick connector Show

XP1	NW26-ID25	XP2	NW26-ID25	XP5	NW26-ID25		
							
PA 29x2.0 ODxWT		PA 29x2.0 ODxWT		PA 29x2.0 ODxWT			
XP3	NW26-ID25	XP4	NW26-ID25				
							
PA 29x2.0 ODxWT		PA 29x2.0 ODxWT					







VDA NW32/NW26/NW40

Steel wire lock Quick connector Show

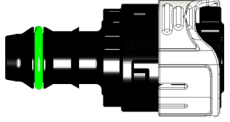
OB1	NW32-ID20-ID32	OB2	NW32-ID32	OB3	NW32-ID32		
							
Rubber 32/20 ID		Rubber32 ID		Rubber32 ID			
OB4	NW26-ID32	OB5	NW26-ID32				
PA 35x1.5 ODxWT		PA 35x1.5 ODxWT					
YZ1	NW40-ID40	YZ2	NW40-ID40	YZ3	NW40-ID40		
							
PA 44x2.0 ODxWT		PA 44x2.0 ODxWT		PA 44x2.0 ODxWT			

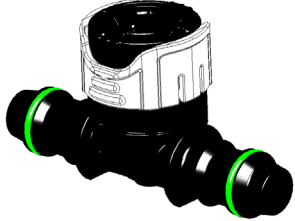
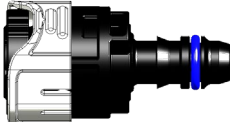
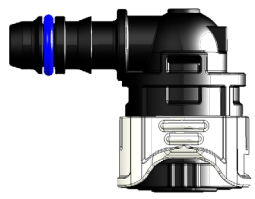
CQC 10.0/14.0

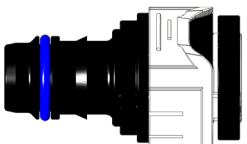
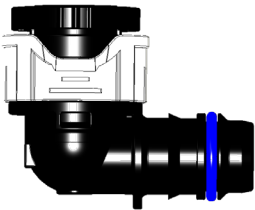
Cooling system Quick Connectors Show

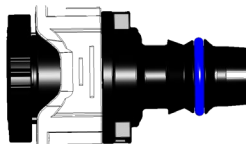
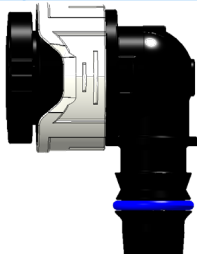
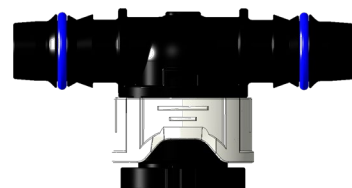
YA9	10.0-ID8	YA10	10.0-ID8-L	YA11	10.0-ID8-T		
							
PA 8.0 ID		PA 8.0 ID		PA 8.0 ID			
YA15	10.0-ID6	YA16	10.0-ID6-L	YA17	10.0-ID6-T	YA28	10.0-ID6
							
PA 6.0 ID		PA 6.0 ID		PA 6.0 ID		PA 6.0 ID	
YA1	14.0-ID12	YA2	14.0-ID12-L	YA3	14.0-ID12-T	YA4	14.0-ID6
							
PA 12.0 ID		PA 12.0 ID		PA 12.0 ID		PA 6.0 ID	
YA12	14.0-ID10	YA13	14.0-ID10-L	YA14	14.0-ID10-T		
							
PA 10.0 ID		PA 10.0 ID		PA 10.0 ID			

快速连接器有O型环和工程塑料件组成，我们需要了解规格以及使用环境，正确为您推荐合适的连接器。

Connectors are supplied with o-rings and plastic material combinations. To determine correct choices, we must have specification and information on operating conditions.

执行标准：SAE J2044-2009 地面车辆推荐规范-液体燃料和气体排放系统用快速连接规范

Superseding J2044 AUG2009 Quick Connect Coupling Specification for Liquid Fuel and Vapor/Emissions Systems

CQC 14.0/18.0

Cooling system Quick Connectors Show

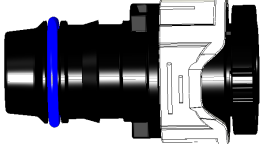
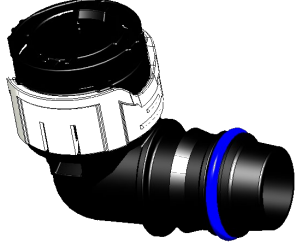
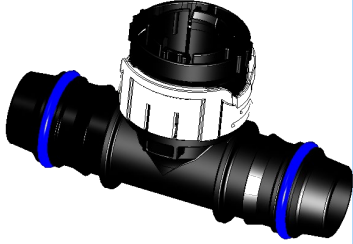
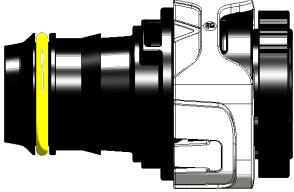
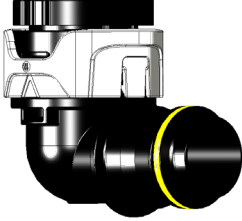
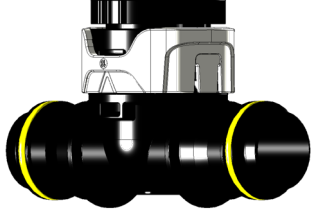
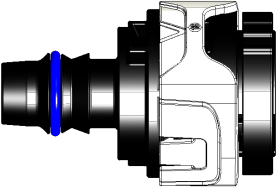
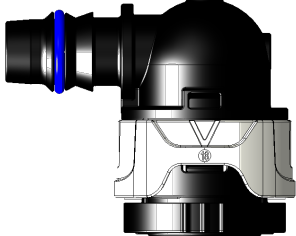
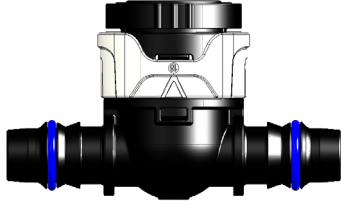
YA18	14.0-ID14	YA19	14.0-ID14-L	YA20	14.0-ID14-T	
						
PA 14.0 ID	PA 14.0 ID	PA 14.0 ID				
YA8	18.0-ID15	YA6	18.0-ID15-L	YA7	18.0-ID15-T	
						
PA 15.0 ID	PA 15.0 ID	PA 15.0 ID				
YA21	18.0-ID10	YA22	18.0-ID10-L	YA23	18.0-ID10-T	
						
PA 10.0 ID	PA 10.0 ID	PA 10.0 ID				

快速连接器有O型环和工程塑料件组成，我们需要了解规格以及使用环境，正确为您推荐合适的连接器。

Connectors are supplied with o-rings and plastic material combinations. To determine correct choices, we must have specification and information on operating conditions.

执行标准：SAE J2044-2009 地面车辆推荐规范-液体燃料和气体排放系统用快速连接规范

Superseding J2044 AUG2009 Quick Connect Coupling Specification for Liquid Fuel and Vapor/Emissions Systems

CQC 14.0/18.0

Cooling system Quick Connectors Show

YA52	14.0-ID12	YA53	14.0-ID12-L	YA54	14.0-ID12-T	YA33	14.0-OD12
							
PA 12.0 ID		PA 12.0 ID		PA 12.0 ID		PA 12.0 OD	
YA55	14.0-ID15	YA56	14.0-ID15-L	YA57	14.0-ID15-T	YA34	14.0-OD12-L
							
PA 15.0 ID		PA 15.0 ID		PA 15.0 ID		PA 12.0 OD	
YA58	18.0-ID15	YA59	18.0-ID15-L	YA60	18.0-ID15-T	YA37	18.0-OD16
		Button can be rotated 90° 		Button can be rotated 90° 			
PA 15.0 ID		PA 15.0 ID		PA 15.0 ID		PA 16.0 OD	
FC-S14-A	14.0	FC-S18-A	18.0	CQC14-012-012		YA38	18.0-OD16
CQC double button 14.0 end cap 		CQC double button 18.0 end cap 		CQC T shape Button can be rotated 90° 		Button can be rotated 90° 	
						PA 16.0 OD	

CQC 14.0/18.0

Cool systems Quick Connectors Show

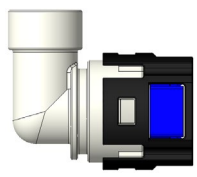
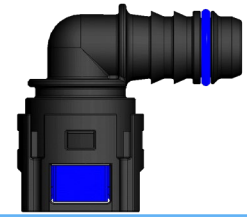
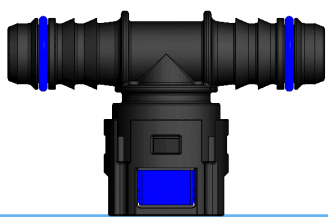
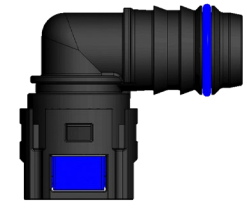
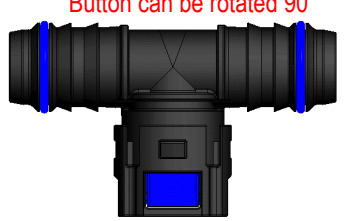
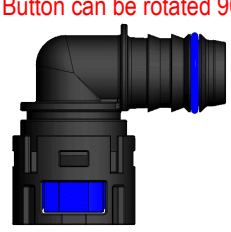
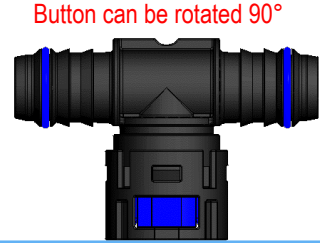
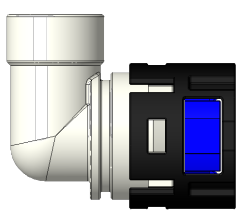
YA34-90	14.0-OD12-L	YA53 -90	14.0-ID12-L	YA54 -90	14.0-ID12-T	YA56-90	14.0-ID15-L
 <p>Button can be rotated 90°</p>		 <p>Button can be rotated 90°</p>		 <p>Button can be rotated 90°</p>		 <p>Button can be rotated 90°</p>	
PA 12.0 ID		PA 12.0 ID		PA 12.0 ID		PA 15.0 ID	
YA57-90	14.0-ID15-T	YA59-60	18.0-ID15-L	YA60-90	18.0-ID15-T	YA38-90	18.0-OD16
 <p>Button can be rotated 90°</p>		 <p>Button can be rotated 90°</p>		 <p>Button can be rotated 90°</p>		 <p>Button can be rotated 90°</p>	
PA 15.0 ID		PA 15.0 ID		PA 15.0 ID		PA 16.0 OD	

快速连接器有O型环和工程塑料件组成，我们需要了解规格以及使用环境，正确为您选择合适的连接器。

Connectors are supplied with o-rings and plastic material combinations. To determine correct choices, we must have specification and information on operating conditions.

T1	ID6-T	T2	ID8-T	T3	ID7.5-ID3-ID8-T	T4	ID4-T
PA 8.0x1.0 ODxWT		PA 10.0x1.0 ODxWT		PA 8 & Rubber 7.5/3.0 ID		PA 6.0x1.0 ODxWT	
T5	ID8-T	T6	ID6-ID10-ID6-T	T7	ID9-T	T8	ID6-7.89-ID6-T
PA 10.0x1.0 ODxWT		PA 6 & 10 ID		PA 12.0x1.5 ODxWT		PA 8.0x1.0 ODxWT 7.89	
T9	ID12-T	T10	ID20-ID10-ID20-T	T11	ID6-ID4-ID6-T	T13	ID35-ID32-ID35-T
PA 15x1.5 ODxWT		PA 20 & Rubber 4.0 ID		PA 6 & Rubber 4.0 ID		Rubber 35/32 ID	
T14	ID8-ID10-ID8-T	T15	ID6-T	T16	ID5/8-ID3/8-ID5/8-T	T17	ID10-T
PA 8 & Rubber 10.0 ID		PA 8.0x1.0 ODxWT		Rubber 8/5 and 3/8 ID		PA 12.5x1.25 ODxWT	

快速连接器有O型环和工程塑料件组成，我们需要了解规格以及使用环境，正确为您推荐合适的连接器。

Connectors are supplied with o-rings and plastic material combinations. To determine correct choices, we must have specification and information on operating conditions.

执行标准：SAE J2044-2009 地面车辆推荐规范-液体燃料和气体排放系统用快速连接规范

Superseding J2044 AUG2009 Quick Connect Coupling Specification for Liquid Fuel and Vapor/Emissions Systems

T19	ID6-7.89-ID6T	T20	ID16-T	T21	ID20-T	T22	ID8.0-ID6-ID6-T
							
PA 8.0x1.0 ODxWT /7.89		PA 19.0x1.5 ODxWT		Rubber 20 ID		PA 6 & Rubber 8.0 ID	
T23	ID6-ID8.0-ID6-T	T24	ID8.0-T	T25	ID14-T	T26	ID12-ID8-ID12-T
							
PA 6 & Rubber 8.0 ID		Rubber 8.0 ID		PA 17.0x1.5 ODxWT		PA 12 and 8 ID	
T27	ID12-ID10-ID12-T	T28	ID12-9.49-ID12-T	T29	ID8-ID6-ID8-T	T30	ID25-T
							
PA 12 and 10 ID		PA 12 and 9.49 OD		PA 6 & Rubber 8.0 ID		PA 29.0x2.0 ODxWT	
Z35	ID32.0-T	Z36	ID38-ID10-ID38-T	Z37	ID35-ID15-ID35-T	Z38	ID60-ID30-ID60-T
							
401/M2442		401/M3024		d-30-926496-		401-n7559-1	
Rubber 32.0 ID		Rubber 38 & 10 ID		Rubber 35 and 15 ID		Rubber 60 and 30 ID	











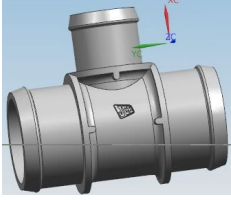

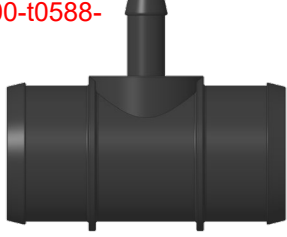
快速连接器有O型环和工程塑料件组成，我们需要了解规格以及使用环境，正确为您选择合适的连接器。

Connectors are supplied with o-rings and plastic material combinations. To determine correct choices, we must have specification and information on operating conditions.

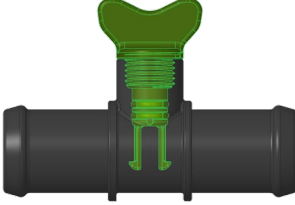
执行标准：SAE J2044-2009 地面车辆推荐规范-液体燃料和气体排放系统用快速连接规范

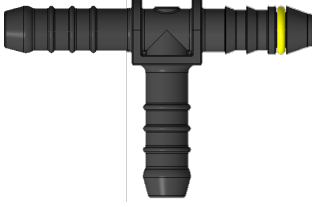
Superseding J2044 AUG2009 Quick Connect Coupling Specification for Liquid Fuel and Vapor/Emissions Systems

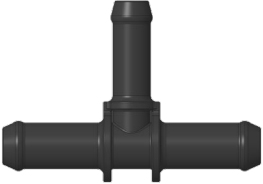
Line Adapter Show

T31	ID48-48-32-T	T32	ID48-48-12-T	T33	55,55,16 T	T34	ID48-48-22-T
92-2753		400/R3673		400-t0588-		334/K3202	
Rubber 48 & 32 ID		Rubber 48 and 12 ID		Rubber 55 and 16 ID		Rubber 48 & 22 ID	
T35	DC T connector	klod4-3	OD4-T	PFST	Discharge Tee	T36	X12128000071
X121280000063-10						Temperature sensor butt connector	
Rubber 24 and 7 ID		PA 4.0x1.0 ODxWT		Rubber 19 ID		PA 27 and M10*1	
T37	ID4.0 Tee	T38	ID6-ID8.0-ID6-T	T39	Tee	T40	Tee
				x121270000150-4			
Rubber 4.0 ID		PA 6 & Rubber 8.0 ID		PA 27 & Rubber 19 & 30 ID		Rubber 9 & 11 ID	
T41	ID50.8-50.8-25.4-T						
							
Rubber 2" & 1" ID							

YA30	ID12 (ID10) - ID25-Three way	YA31	ID12 (ID8) - ID25-Three way	YA32	ID25-ID14 Three way	YA49	ID25 - ID15 (ID14) Three way
				ID 8mm: YA32-8	ID 10mm: YA32-10	ID 9mm: YA49-9	
PA 25 and 12 ID	PA 25 and 12 ID	PA 25 and 14 ID	PA 25 and 15 ID				
YA5	14.0-ID25-Three way	YA25	18.0-ID25-Three way	YA26	18.0-ID10-Three way	YA29	18.0-ID12-Three way
	ID 8mm: YA25-8 ID 10mm: YA25-10 ID 12mm: YA25-12						
PA 25 ID and CQC14.0	PA 25 ID and CQC18.0	PA 10 ID and CQC18.0	PA 12 ID and CQC 18.0				
YA39	15.82-ID25 Three way	YA40	ID25-15.82-M14x1.5-Three way	YA43	ID25-CQC18.0-M14x1.5-Three way	YA47	ID25-ID15-M14x1.5-Three way
		ID 10mm: YA43-10					
PA 25 ID and SAE 15.82	PA 25 ID and SAE 15.82	PA 25 ID and CQC18.0	PA 25 and 15 ID				
YA45	ID25-elbow Three way with M14x1.5	YS1	ID25-CQC18.0 Three way	YS2	ID25-ID10-CQC18.0-Three way	YS3	ID25-ID10-CQC18.0-4 way
PA 25 ID and M14x1.5	PA 25 ID and CQC18.0	PA 25&10 ID and CQC18.0	PA 25&10 ID and CQC18.0				

快速连接器有O型环和工程塑料件组成，我们需要了解规格以及使用环境，正确为您选择合适的连接器。

Connectors are supplied with o-rings and plastic material combinations. To determine correct choices, we must have specification and information on operating conditions.

执行标准：SAE J2044-2009 地面车辆推荐规范-液体燃料和气体排放系统用快速连接规范

Superseding J2044 AUG2009 Quick Connect Coupling Specification for Liquid Fuel and Vapor/Emissions Systems

Line Adapter Show

Y1	ID6-Y	Y2	ID8-ID8-ID8-Y	Y3	ID6.0-Y	Y4	ID8-Y
							
PA 8 & Rubber 3.0 ID		Rubber 8.0 & 6.0 ID		PA 6 and 9.49 & 7.89 QC		PA 8 and 9.49 QC	
Y5	ID8-Y	Y6	ID14-ID6-ID14-Y	Y7	ID16-ID6-ID14-Y	Y8	Y shape
							
Rubber 8.0 ID		PA 14 and 6 ID		PA 16 & 14 & 6 ID		PA 27 and Rb 29 ID	
FB21	ID9-Y	FB22	ID7-ID9-ID9-Y	FB30	ID6--Y	230-T1	ID9-NG8-ID9-T
							
PA 12x1.5 ODXWT		PA 7 and 9 ID		PA 9x1.5 ODXWT		PA 9 & M16x1.5-6H ID	
S1	ID4-S	S2	7.89-ID4-ID6-ID6-S	S3	7.89-ID6-ID4-ID6-S	KS1	ID15-ID15-ID6-ID15-KS
							
PA 6.0x1.0 ODXWT		PA 4 & 6 ID 7.89 QC		PA 4 & 6 ID 7.89 QC		PA 15 & 6 ID	



快速连接器有O型环和工程塑料件组成，我们需要了解规格以及使用环境，正确为您推荐合适的连接器。

Connectors are supplied with o-rings and plastic material combinations. To determine correct choices, we must have specification and information on operating conditions.

执行标准：SAE J2044-2009 地面车辆推荐规范-液体燃料和气体排放系统用快速连接规范

Superseding J2044 AUG2009 Quick Connect Coupling Specification for Liquid Fuel and Vapor/Emissions Systems

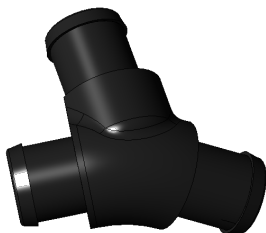
Line Adapter Show

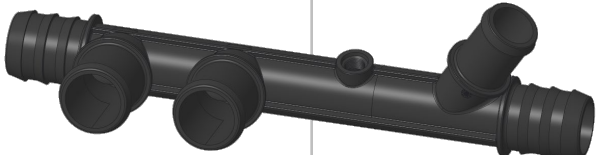
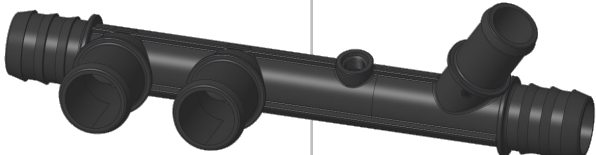















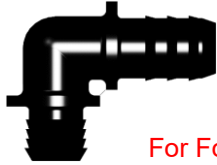

FB1	Reducing Tees	FB2	Reducing Tees	FB5	Reducing Tees	FB11	Reducing Tees
	For SAIC		For SAIC				For SAIC
PA 8 & Rubber 3.0 ID		Rubber 8.0 & 6.0 ID		PA 6 and 9.49 & 7.89 QC		PA 8 and 9.49 QC	
QS1	ID28 Tilt Tee	FB32	ID6&ID9Y	KZ21	NW12-ID15-L	S4	With M10x1 thread 4 ways
							X12130000082-1
Rubber 28.0 ID		PA 9 & 6 ID		Rubber 15.0 and NW12		两端对接φ31x2尼龙管, 中间螺纹孔安装传感器, 45度得是适配φ24x4胶管的,	
NO.	OD148.OD148	NO.	OD155.OD155	NO.	OD175.OD175	NO.	ZJ100.OD148
							
焊接等径OD14.8水路对接直接头		焊接等径OD15.5水路对接直接头		焊接等径OD17.5水路对接直接头		PA ID10&焊接OD14.8水路对接直接头	
NO.	ZJ100.OD155	NO.	ZJ120.OD175	S5	With M10x1 thread 6 ways	S6	6 ways (No threaded holes)
							X12128000096-5
PA ID10&焊接OD15.5水路对接直接头		PA ID13&焊接OD17.5水路对接直接头		两端对接φ31x2尼龙管, 中间螺纹孔安装传感器, 45度得是适配φ24x4胶管的, 另连个是对接φ19x4胶管			

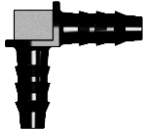
快速连接器有O型环和工程塑料件组成, 我们需要了解规格以及使用环境, 正确为您推荐合适的连接器。

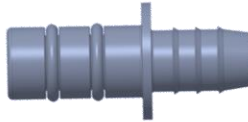
Connectors are supplied with o-rings and plastic material combinations. To determine correct choices, we must have specification and information on operating conditions.

执行标准: SAE J2044-2009 地面车辆推荐规范-液体燃料和气体排放系统用快速连接规范

Superseding J2044 AUG2009 Quick Connect Coupling Specification for Liquid Fuel and Vapor/Emissions Systems

Z1	ID6-Z	Z2	ID7-ID10-Z	Z3	ID3-Z	Z4	ID22-ID12-Z
							
PA 8x1 OD×WT		PA 7 and Rubber 10.0 ID		Rubber 3.0 ID		Rubber 22 & 12 ID	
Z5	ID7.5-ID6-Z	Z6	ID7.5-ID8-Z	Z7	ID7.5-ID6-L	Z8	ID8-L
							
Rubber 7.5 and PA 6 ID		Rubber 7.5 and PA 8 ID		Rubber 7.5 and PA 6 ID		PA 10x1 OD×WT	
Z9	Adapter	Z10	Adapter	Z11	ID8-ID9.5--Z	Z12	ID6-L
							
For Ford PA 11 ID Embedded Rubber		For Ford PA16 ID Embedded Rubber		Rubber 9.5 and PA 8 ID		PA 8x1 OD×WT	
Z13	ID22-ID21-Z	Z14	ID16-ID14-Z	Z15	Adapter straight	Z16	ID20-Z
							
Rubber 22 and PA 21 ID		Rubber 16 and PA 14 ID		PA 12 ID		Rubber 20.0 ID	
Z17	ID10-ID9.5-Z	Z18	Adapter elbow	Z19	ID14-ID10-Z	Z20	ID12-ID14-Z
							
Rubber 9.5 and PA 10 ID		Rubber 9.5 ID Embedded Rubber F115.203.01		Rubber 14 and PA 10 ID		Rubber 12 and PA 14 ID	

快速连接器有O型环和工程塑料件组成，我们需要了解规格以及使用环境，正确为您选择合适的连接器。









Connectors are supplied with o-rings and plastic material combinations. To determine correct choices, we must have specification and information on operating conditions.

执行标准：SAE J2044-2009 地面车辆推荐规范-液体燃料和气体排放系统用快速连接规范

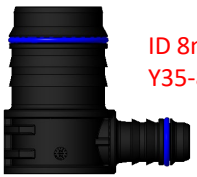
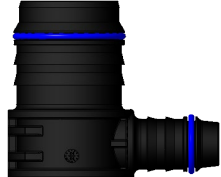
Superseding J2044 AUG2009 Quick Connect Coupling Specification for Liquid Fuel and Vapor/Emissions Systems

Z21	ID9.5-ID8-L	Z22	ID9-L	Z23	ID7.5-ID6-Z	Z24	ID6.5-Z
							
Rubber 9.5 and PA 8 ID	PA 9 ID	Rubber 7.5 and PA 6 ID	Rubber 6.5 ID				
Z25	ID5.5-Z	Z26	ID52-Z	Z27	ID14.0-ID12-L	Z28	ID12-OD12-Z
							
Rubber 5.5 ID	Rubber 52.0 ID	Rubber 14 and PA 12 ID	PA 12 OD Rubber 12 ID				
Z29	ID14.0-Z	Z30	ID16-ID14-Z	Z31	ID16-ID19--Z	Z32	ID10-Z
							
Rubber 14.0 ID	Rubber 16 and PA 14 ID	Rubber 19 and PA 16 ID	PA 12.5x1.25 ODxWT				
Z33	ID8-Z	Z34	ID14-L	Z39	Adapter straight	Z40	ID10-Z
							
PA 10x1.0 ODxWT	PA 17x1.5 ODxWT	9.49 QC and PA 12 ID	PA 12.5x1.25 ODxWT				
Z41	ID14-Z	Z42	ID25-L	Z44	Rubber hose adapter	YA45	Rubber hose adapter
							
PA 17x1.5 ODxWT	PA 29x2 ODxWT	X121280000063-91 PA 27 and Rb 29 ID	X121280000068-12 PA 25 and Rb 25 ID				

Line Adapter Show

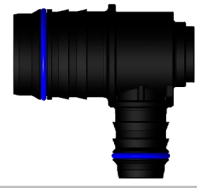
Z46	Rubber hose adapter	Z47	Rubber hose adapter	Z48	Hose adaptor		
X12130000058-70		17PA-17RB					
PA 18 and Rb 19 ID		PA 17 and Rb 17 ID		Rb 9 and Rb 11 ID			
YA35	ID25-ID12-L	YA36	ID25-ID14-L	YA41	ID25-15.82-L	YA44	ID25-18.0-L
	ID 8mm: Y35-8						ID 10mm: Y44-10
PA 25 and 12 ID		PA 25 and 14 ID		PA 25 ID and SAE 15.82		PA 25 ID and CQC18.0	
YA27	ID25-18.0-L	YA24	ID25-14.0-L	YA46	ID25-L	YA48	ID25-ID15-L
							
PA 25 ID and CQC18.0		PA 25 ID and CQC14.0		PA 29x2 ODXWT		PA 25 and 15 ID	

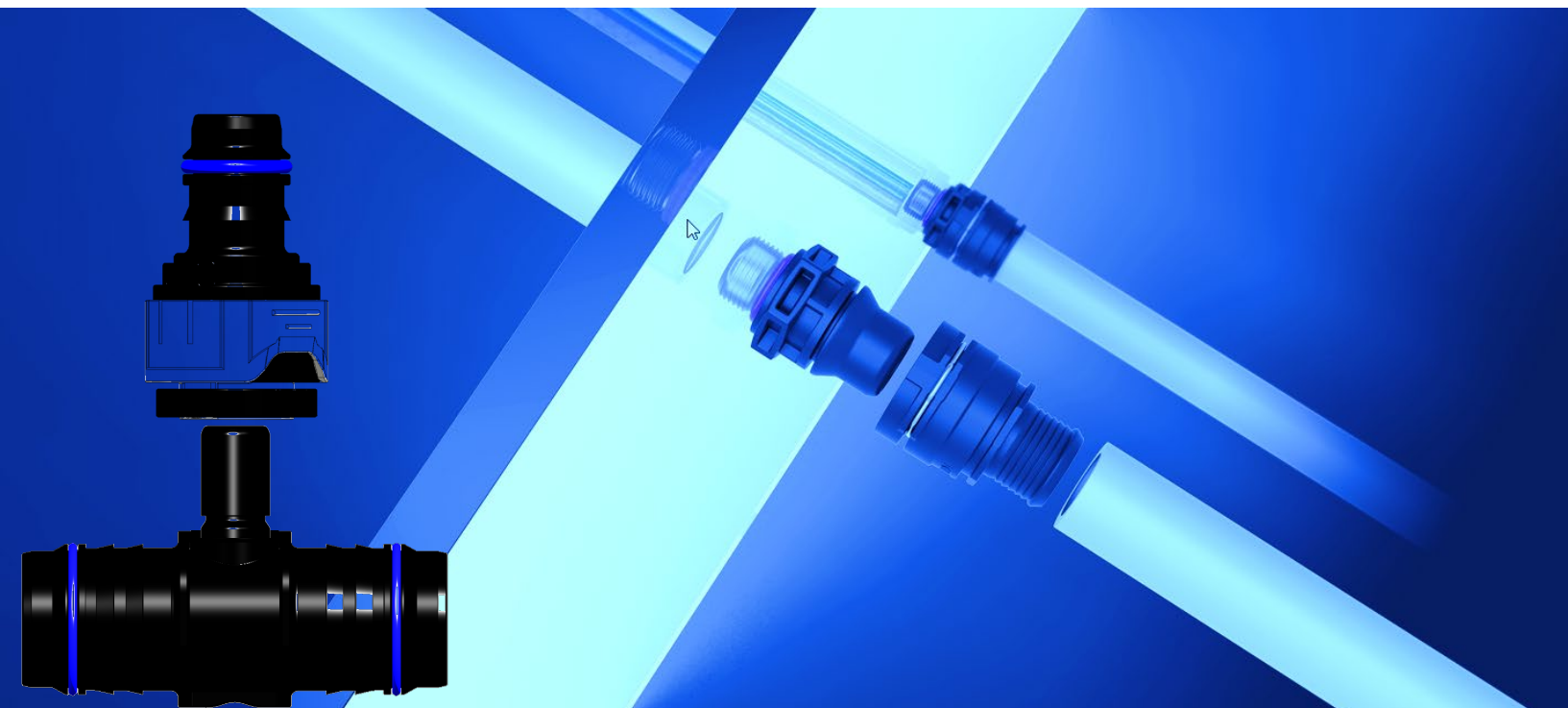

快速连接器有O型环和工程塑料件组成，我们需要了解规格以及使用环境，正确为您选择合适的连接器。











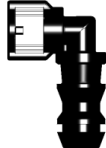

Connectors are supplied with o'rings and plastic material combinations. To determine correct choices, we must have specification and information on operating conditions.

执行标准：SAE J2044-2009 地面车辆推荐规范-液体燃料和气体排放系统用快速连接规范

Superseding J2044 AUG2009 Quick Connect Coupling Specification for Liquid Fuel and Vapor/Emissions Systems

刮雨器快速接头
Wiper pipe









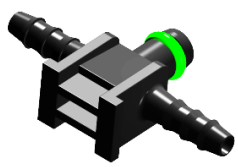
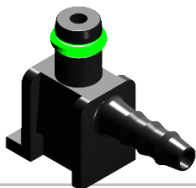

Wiper Pipe Quick Connector

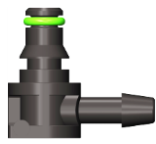
YG1	9.5-ID8	YG2	9.5-ID8-L	YG3	7.05-ID4.5	YG4	7.05-ID4.5-L
							
Rubber 8.0 ID		Rubber 8.0 ID		Rubber 4.5 ID		Rubber 4.5 ID	
YG5	7.05-ID4.5-T	YG6	7.05-ID8-L	YG7	7.05-ID8-125°	YG8	7.05-ID4.5-135°
							
Rubber 4.5 ID		Rubber 8.0 ID		Rubber 8.0 ID		Rubber 4.5 ID	
YG-MEP1	Big end	YG-MEP2	Small end	YG-MEP3	L end		
							
Rubber 8.0 ID and Big QC		Small QC		Big end & Small end			
YG-T1	ID4.5-7.05-ID4.5-T	YG-Y1	3-Small QC-Y	YG-Y2	3-Small QC-Y		
							
Rubber 4.5 ID and Small QC		Small QC		Small QC			

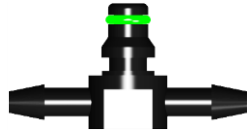
快速连接器有O型环和工程塑料件组成，我们需要了解规格以及使用环境，正确为您推荐合适的连接器。
Connectors are supplied with o-rings and plastic material combinations. To determine correct choices, we must have specification and information on operating conditions.
执行标准：SAE J2044-2009 地面车辆推荐规范-液体燃料和气体排放系统用快速连接规范
Superseding J2044 AUG2009 Quick Connect Coupling Specification for Liquid Fuel and Vapor/Emissions Systems

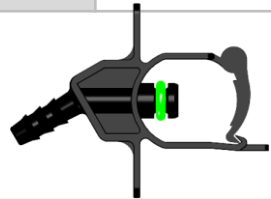
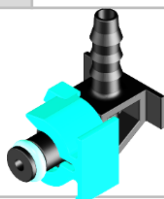
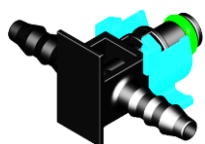
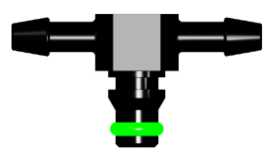
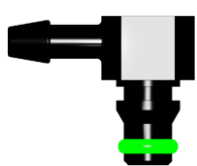
回油管快速接头 Oil Return Pipe

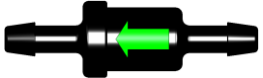
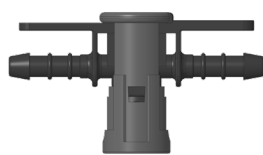
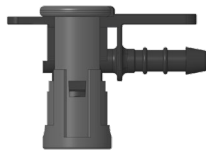
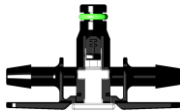
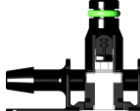
Oil Return Pipe Quick Connector

FB3	D7.0-ID4-T	FB4	D7.0-ID4-L	FB6	D5.8-ID4-L	FB7	D5.8-ID4-L
							
PA 6x1 ODxWT		PA 6x1 ODxWT		PA 6x1 ODxWT		Rubber 4.0 ID	
FB8	D5.8-ID4-three	FB9	D5.8-ID4-T	FB10	D5.8-ID4-L	FB12	D5.8-ID4-L
							
Rubber 4.0 ID		Rubber 4.0 ID		Rubber 4.0 ID		PA 6x1 ODxWT	
FB13	D5.8-ID4-L	FB14	D5.8-ID4-T	FB15	D5.8-ID4-T	FB16	D5.8-ID4-L
							
PA 6x1 ODxWT		PA 6x1 ODxWT		Rubber 4.0 ID		Rubber 4.0 ID	
FB17	D5.8-ID4-L	FB18	ID4 Two-way valve	FB33	Tee	FB34	Elbow
							
PA 6x1 ODxWT		Rubber 4.0 ID		Rubber 4.0 ID		Rubber 4.0 ID	
FB28	D5.8-ID4-T	FB29	D5.8-ID4-L	FB35	Tee		
							
Rubber 4.0 ID		Rubber 4.0 ID		Rubber 4.0 ID			



快速连接器有O型环和工程塑料件组成，我们需要了解规格以及使用环境，正确为您推荐合适的连接器。

Connectors are supplied with o-rings and plastic material combinations. To determine correct choices, we must have specification and information on operating conditions.

执行标准：SAE J2044-2009 地面车辆推荐规范-液体燃料和气体排放系统用快速连接规范

Superseding J2044 AUG2009 Quick Connect Coupling Specification for Liquid Fuel and Vapor/Emissions Systems

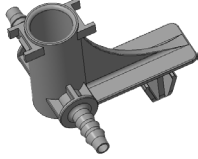
Oil Return Pipe Quick Connector Show

FB19	ID4 Sensors can be installed	FB20	Black and white pipe fittings				
							
PA 6x1 ODXWT							

NW-1	D12-ID6-180°	NW-2	D12-ID6-90°	NW-3	D12-ID8-180°	NW-4	D12-ID8-90°
							
PA 8.0x1.0 ODxWT		PA 8.0x1.0 ODxWT		PA 10.0x1.0 ODxWT		PA 10.0x1.0 ODxWT	
NW-5	D16-ID9-180°	NW-6	D16-ID9-90°	NW-7	D12-ID6-60°	NW-8	D10-ID6-180°
							
PA 12.5x1.5 ODxWT		PA 12.5x1.5 ODxWT		PA 8.0x1.0 ODxWT		PA 8.0x1.0 ODxWT	
NW-9	D16-ID10-180°	NW-10	D16-ID10-90°	NW-11	D16-ID12-180°	NW-12	D16-ID12-90°
							
PA 12.5x1.25 ODxWT		PA 12.5x1.25 ODxWT		PA 15.0x1.5 ODxWT		PA 15.0x1.5 ODxWT	
NW-13	D16-ID8-180°	NW-14	D16-ID8-90°	NW-15	D16-ID9-180°	NW-16	D16-ID9-90°
							
PA 10.0x1.0 ODxWT		PA 10.0x1.0 ODxWT		PA 12.5x1.5 ODxWT		PA 12.5x1.5 ODxWT	

快速连接器有O型环和工程塑料件组成，我们需要了解规格以及使用环境，正确为您选择合适的连接器。

Connectors are supplied with o-rings and plastic material combinations. To determine correct choices, we must have specification and information on operating conditions.

执行标准：SAE J2044-2009 地面车辆推荐规范-液体燃料和气体排放系统用快速连接规范

Superseding J2044 AUG2009 Quick Connect Coupling Specification for Liquid Fuel and Vapor/Emissions Systems

NW-17	D12-ID8-180°	NW-18	D12-ID8-90°	NW-19	D16-ID12-180°	NW-20	D16-ID12-90°
							
PA 10x1	OD×WT	PA 10x1	OD×WT	PA 15.0x1.5	OD×WT	PA 15.0x1.5	OD×WT
NW-21	D16-ID10-180°	NW-22	D16-ID10-90°	NW-23	D12-ID8-45°	NW-24	D16-ID6-90°
							
PA 12.5x1.25	OD×WT	PA 12.5x1.25	OD×WT	PA 10x1	OD×WT	PA 8x1	OD×WT
NW-14-SY	D16-ID8-90°	NW-25	D12-OD5-90°	NW-21-S	D16-ID10	NG12-Z	NG12-NW10
							
PA 10x1	OD×WT	PA 5	OD	PA 12.5x1.25	OD×WT	PA 10 ID and NG12	
NG12-SZ	NG12-NW10	NG12-ZD	NG12 end cap	NG12-SZD	Error proof end cap	NG12-Z	NG12-NW10
							
NG12 Inner hole with steps				NG12 Inner hole with steps			
PA 10 ID and NG12 Error-proofing		NG12 end cap		NG12 error-proofing end cap		PA 10 ID and NG12	

快速连接器有O型环和工程塑料件组成，我们需要了解规格以及使用环境，正确为您推荐合适的连接器。
 Connectors are supplied with o-rings and plastic material combinations. To determine correct choices, we must have specification and information on operating conditions.
 执行标准：SAE J2044-2009 地面车辆推荐规范-液体燃料和气体排放系统用快速连接规范
 Superseding J2044 AUG2009 Quick Connect Coupling Specification for Liquid Fuel and Vapor/Emissions Systems

230

230 QC

230-1	D15-ID9-180°	230-2	D15-ID9-90°	230-3	D15-ID9-90°	230-4	D15-ID9-M16
							
PA 12x1.5 OD×WT		PA 12x1.5 OD×WT		PA 12x1.5 OD×WT		PA 12x1.5 OD×WT	
230-5	D15-ID9-M16	230-1LL	D15-ID9-180°	230-2LL	D15-ID9-90°	230-3LL	D15-ID9-90°
							
PA 12x1.5 OD×WT		PA 12x1.5 OD×WT		PA 12x1.5 OD×WT		PA 12x1.5 OD×WT	

DN6



DN6接头展示
DN6 QC

DW-1	D11.5-ID5-90°	DW-2	D11.5-ID5-90°	DW-3	D11.5-ID5-180°		
							
PA 7x1 OD×WT		PA 7x1 OD×WT		PA 7x1 OD×WT			
DN6-1	D11.5-ID5-180°	DN6-5	D11.5-ID5-90°	DN6-9	D11.5-ID5-90°		
							
PA 7x1 OD×WT		PA 7x1 OD×WT		PA 7x1 OD×WT			

快速连接器有O型环和工程塑料件组成，我们需要了解规格以及使用环境，正确为您推荐合适的连接器。
Connectors are supplied with o-rings and plastic material combinations. To determine correct choices, we must have specification and information on operating conditions.
执行标准：SAE J2044-2009 地面车辆推荐规范-液体燃料和气体排放系统用快速连接规范
Superseding J2044 AUG2009 Quick Connect Coupling Specification for Liquid Fuel and Vapor/Emissions Systems

单向阀 Check valve

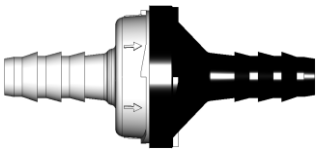
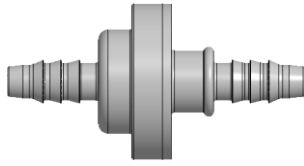
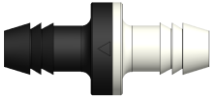
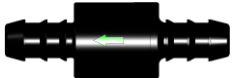
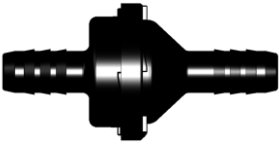
Check Valve Show

DXF-1	ID8 check valve	DXF-2	ID6 check valve	DXF-3	ID8 check valve	DXF-4	ID9 check valve
							
PA 10x1 OD×WT		PA 8x1 OD×WT		PA 10x1 OD×WT		PA 12 x1.5 OD×WT	
DXF-5	ID7 check valve	DXF-6	ID8 check valve-L	DXF-7	ID11 check valve-L		
							
PA 10x1.5 OD×WT		PA 8 ID Embedded Rubber ID15		PA 11 ID Embedded Rubber ID15			

快速连接器有O型环和工程塑料件组成，我们需要了解规格以及使用环境，正确为您选择合适的连接器。
Connectors are supplied with o' rings and plastic material combinations. To determine correct choices, we must have specification and information on operating conditions.
执行标准：SAE J2044-2009 地面车辆推荐规范-液体燃料和气体排放系统用快速连接规范
Superseding J2044 AUG2009 Quick Connect Coupling Specification for Liquid Fuel and Vapor/Emissions Systems

M1 Double hole 90°



适配柳州源创DH020M油嘴
适配 7.89 QC

M2 Single hole 90°



适配柳州源创DH020M油嘴
Rubber 7.5

M3 Single hole 90°



适配柳州源创DH020M油嘴
Rubber 6.0

M4 Right single hole 90°

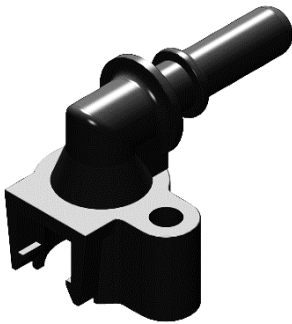

适配柳州源创DH020M油嘴
适配 7.89 QC

M5 Left single hole 90°

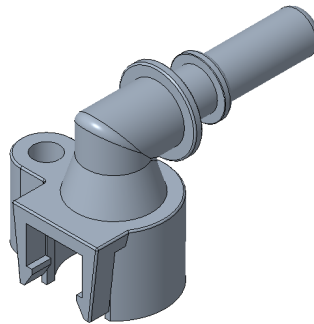

适配柳州源创DH020M油嘴
适配 7.89 QC

M6 偏单孔-90°

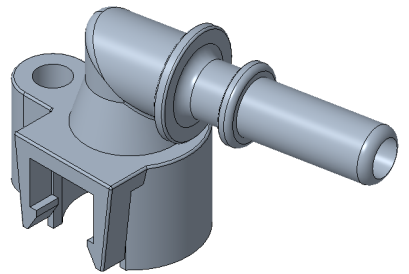

适配柳州源创DH020M油嘴
适配 7.89 QC

M7 双孔-90°

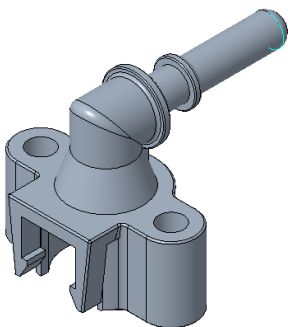

适配柳州源创DH020M油嘴
适配6.30QC

M5-NEW 左单孔-90°

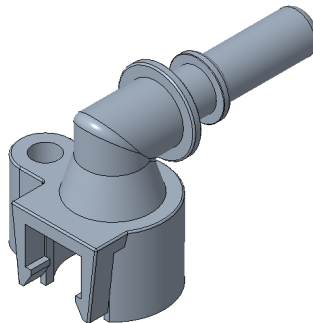

适配柳州源创**新款**DH020M油嘴
适配 7.89 QC

M6-NEW 偏单孔-90°

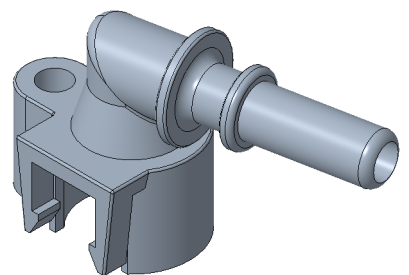

适配柳州源创**新款**DH020M油嘴
适配 7.89 QC

M1-NEW 双孔-90°



适配柳州源创**新款DH020M油嘴**
适配 7.89 QC

M2-NEW 单孔-90°



适配柳州源创**新款DH020M油嘴**
Rubber 7.5

M3-NEW 单孔-90°

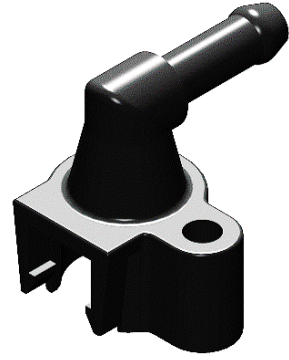

适配柳州源创**新款DH020M油嘴**
Rubber 6.0

M4-NEW 右单孔-90°

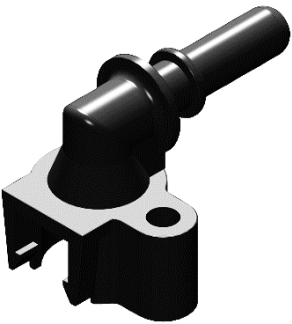

适配柳州源创**新款DH020M油嘴**
适配 7.89 QC

M8 双孔-90°

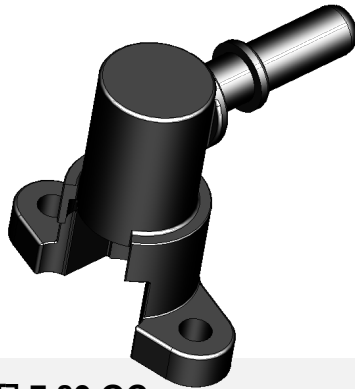

适配 7.89 QC

编号: GJ20-10
双排管夹20-10

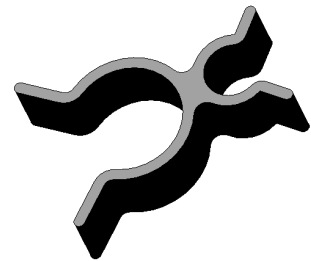

编号: BLP1502J016
双排管夹18-18

1A020287

左侧喷油器支架



1A020186

右侧喷油器支架



编号: ST_105422
10mm双排管夹



编号: ST-105272
双排管夹



快速连接器有O型环和工程塑料件组成, 我们需要了解规格以及使用环境, 正确为您选择合适的连接器。
Connectors are supplied with o-rings and plastic material combinations. To determine correct choices, we must have specification and information on operating conditions.
执行标准: SAE J2044-2009 地面车辆推荐规范-液体燃料和气体排放系统用快速连接器
Superseding J2044 AUG2009 Quick Connect Coupling Specification for Liquid Fuel and Vapor/Emissions Systems

Plug

Quick Connector Plugs

FC1	6.30--Plug	FC2	7.89--Plug	FC3	9.49--Plug	FC4	9.89--Plug
							
Fitted to 6.30 QC		Fitted to 7.89 QC		Fitted to 9.49 QC		Fitted to 9.89 QC	
FC5	11.80--Plug	FC6	12.61--Plug	FC7	15.82--Plug	FC7-A	15.82--Plug
							
Fitted to 11.80 QC		Fitted to 12.61 QC		Fitted to 15.82 QC		Fitted to 15.82 QC (Double buttons)	
FC9	18.0--Plug	FC10	18.9--Plug	FC12	24.0--Plug		
							
Fitted to 18.0 QC		Fitted to 18.9 QC		Fitted to 24.0 QC			
YG-FC1	小雨刮--Plug	YG-FC2	大雨刮--Plug				
							
适配 小雨刮 QC		适配 大雨刮 QC					
FC-NG8	NG8--Plug	FC-NG12	NG12--Plug	FC-230	NG12--Plug		
							
Fitted to 246-NG8 QC		Fitted to 246-NG12 QC		Fitted to 230-NG12 QC			
FC-S10.0	10.0--Plug	FC-S14.0	14.0--Plug	FC-S18.0	18.0--Plug		
							
Fitted to CQC 10.0 QC		Fitted to CQC 14.0 QC		Fitted to CQC 18.0 QC			

快速连接器有O型环和工程塑料件组成，我们需要了解规格以及使用环境，正确为您推荐合适的连接器。

Connectors are supplied with o-rings and plastic material combinations. To determine correct choices, we must have specification and information on operating conditions.

执行标准：SAE J2044-2009 地面车辆推荐规范-液体燃料和气体排放系统用快速连接规范

Superseding J2044 AUG2009 Quick Connect Coupling Specification for Liquid Fuel and Vapor/Emissions Systems

尿素管 Adblue Tube

选用ETFE/PA12复合材料成型的低渗透复合尼龙管，抗腐蚀性优良，尿素的渗透量极低，使用温度为-60℃~+125℃，符合SAE J844标准要求，供给管和回流管内径 $\phi 6\text{mm}$ ，喷射管内径 $\phi 3\text{mm}$ 。接头为自主生产，质量符合SAE J2044-2009标准。

Material: ETFE/PA12 integrated,
Performance Merit: low permeation, corrosion resistance,
Temperature Range : -60°C__+125°C ,
I.D of supply and return line : $\phi 6\text{mm}$
I.D of injection line : $\phi 3\text{mm}$
The tube meets SAE J844 and is fitted with SAE J2044-2009 connector



电加热尿素管 Electro-heating Adblue Tube

内管为上述尿素管，附带自控温电加热功能，电压24 VDC，峰值32 VDC，最大电流<10A，最高限制温度<70℃，加热功率25W/M（10℃时），所有管体两端均安装自主生产的SAE J2044-2009的快速接头。

Electro-heating Adblue tube is ETFE / PA12 integrated tube with heating and self-temp-control .It is fitted with SAE J2044-2009 connector .

Voltage: 24VDC, Peak Value: 32VDC, Max, Current: <10A,
Max.Temperature: <70℃, Heating Power: 25W/M (when 10℃)



尿素喷射管，尿素回液管、加热尿素喷射管、加热尿素回液管

UREA INJECTION PIPE,UREA LIQUID RETURNING PIPE,HEATING OF UREA INJECTION PIPE,HEATING OF UREA LIQUID RETURNING PIPE



农用机系列油管
Agricultural vehicle fuel hose assembly



其他系列油管
Other series fuel hose assembly

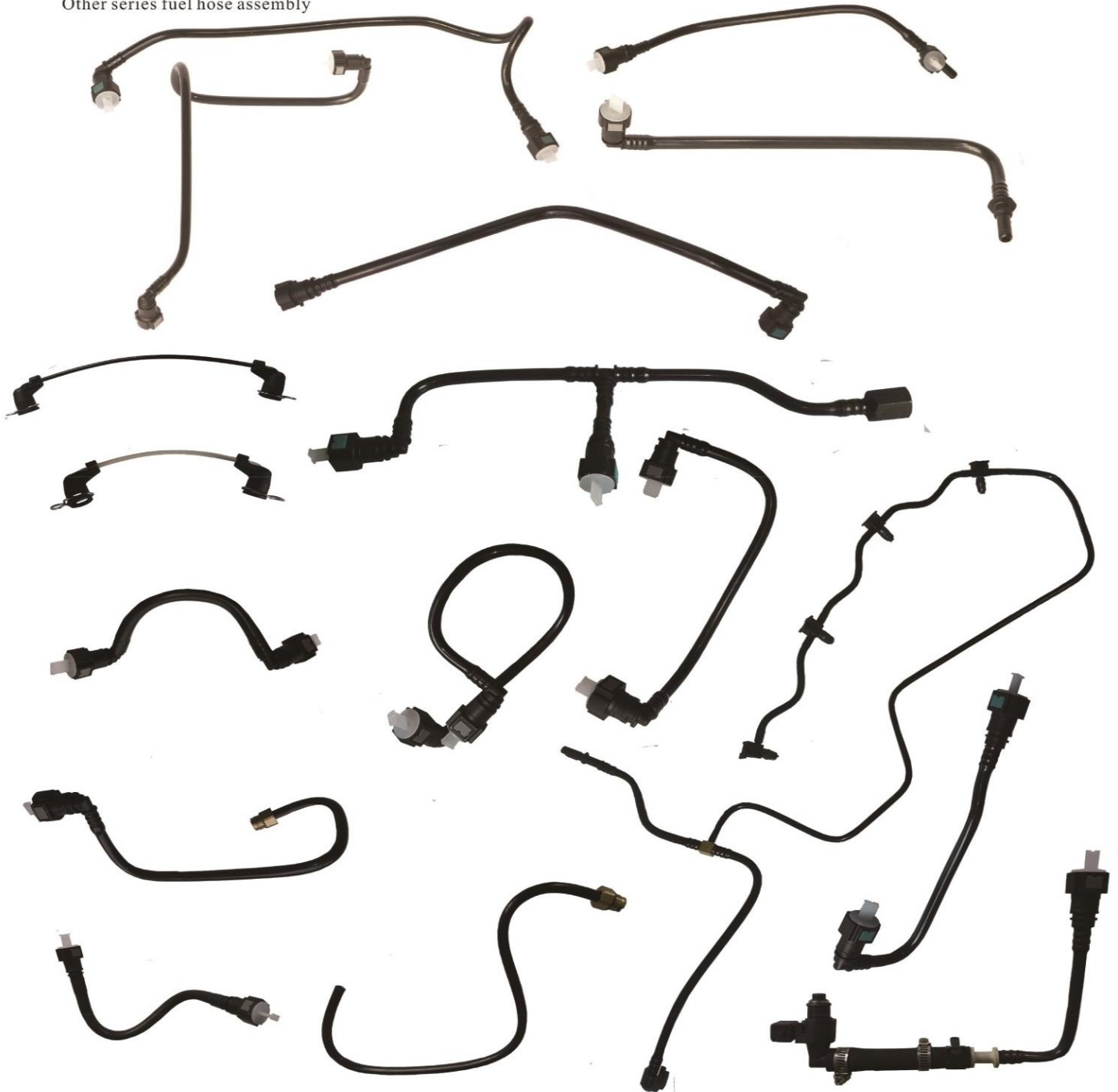

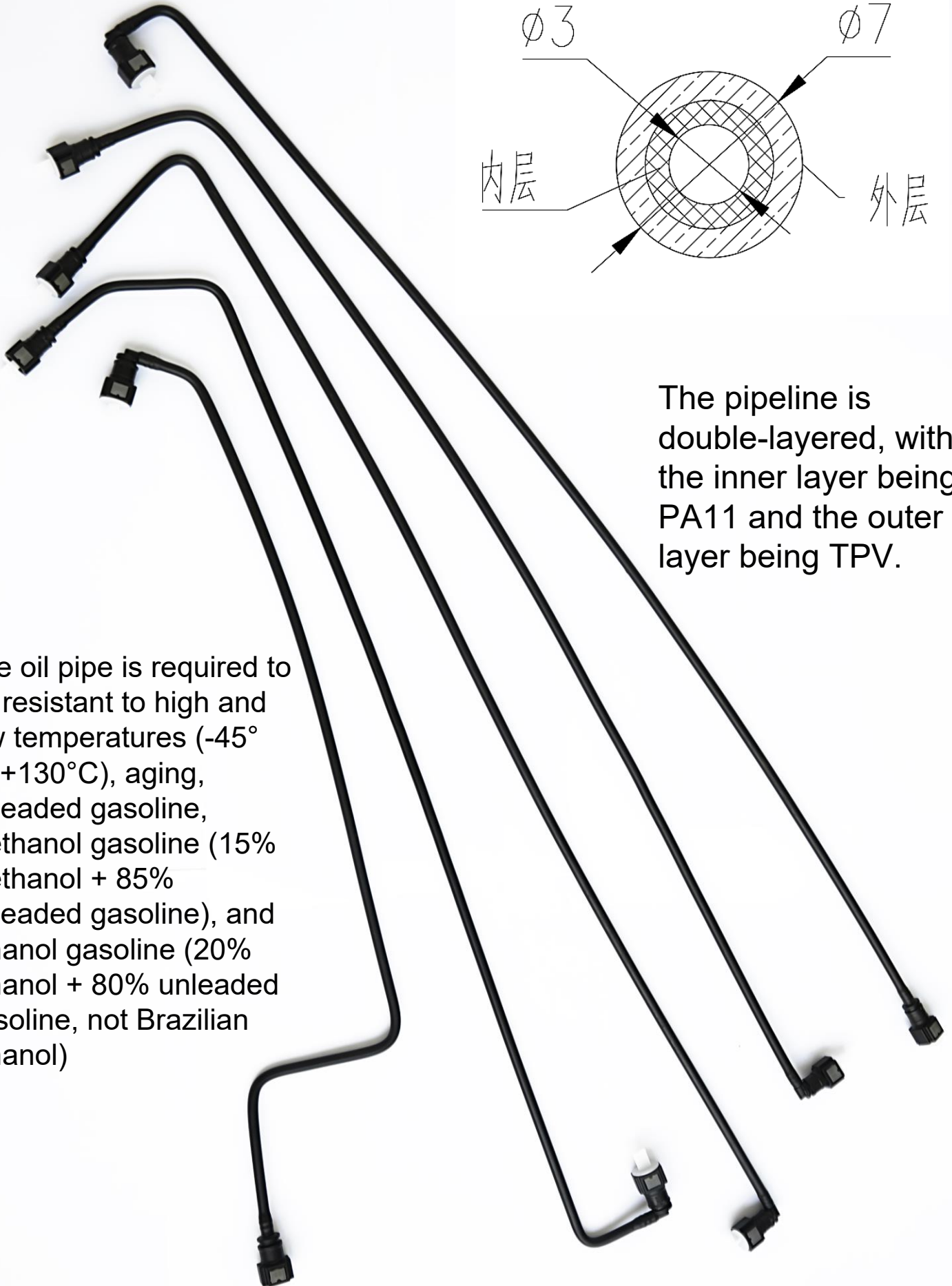

The pipeline is double-layered, with the inner layer being PA11 and the outer layer being TPV.

The oil pipe is required to be resistant to high and low temperatures (-45°C~+130°C), aging, unleaded gasoline, methanol gasoline (15% methanol + 85% unleaded gasoline), and ethanol gasoline (20% ethanol + 80% unleaded gasoline, not Brazilian ethanol)

管路防尘罩展示

Plugg Show

Plugg

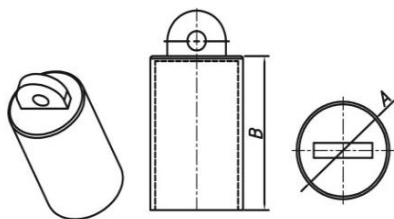

钢丝管护套 (材质: PVC)

编号	名称	A(内径)	B(高度)
SW29#	29#护套	Φ28.5	28.4
SW24#	24#护套	Φ23.8	30
SW21#	21#护套	Φ20.5	29.1
SW17#	17#护套	Φ16.7	28.7
SW14#	14#护套	Φ13.5	28
SW12#	12#护套	Φ11.6	29.1
SW8#	8#护套	Φ7.7	25.1
SW5#	5#护套	Φ4.5	20.5

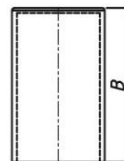

尼龙管护套 (材质: PVC)

序号	名称	A(内径)	B(高度)	适配尼龙管外径
1	16号	Φ15.5	14	16mm
2	12号	Φ11.7	14	12mm
3	10号	Φ9.3	18.8	10mm
4	9号	Φ8.5	14	9mm
5	8号	Φ7.7	14	8mm
6	6号(长)	Φ5.6	20.3	6mm
7	6号(短)	Φ5.6	14	6mm
8	5号	Φ4.6	14	5mm

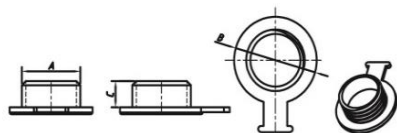

螺母堵头 (材质: PE)

序号	名称	A	B	C
UP27	27X1.5	Φ26.75	Φ34	9.3
UP26	26X1.5	Φ25.3	Φ31.6	5.8
UP24	24X1.5	Φ23.4	Φ31.7	8.85
UP20	20X1.5	Φ19.2	Φ28.2	7.3
UP18	18X1.5	Φ17.3	Φ25.6	7.7
UP16	16X1.5	Φ15.45	Φ21	7.3
UP14	14X1.5	Φ13.5	Φ18.25	8



橡胶管堵头 (材质: 热缩性弹性体)

编号	名称	A	B	H	适配管内径
RB6#	6#堵头	Φ6.8	Φ6	12	6mm
RB8#	8#堵头	Φ8.7	Φ8	11.8	8mm
RB9#	9#堵头	Φ9.5	Φ9.1	9.5	9mm
RB10#	10#堵头	Φ10.5	Φ9.8	12	10mm
RB13#	13#堵头	Φ13.1	Φ12.6	13	13mm
RB16#	16#堵头	Φ16.7	Φ16.3	14	16mm
RB19#	19#堵头	Φ19.5	Φ18.7	19	19mm
RB25#	25#堵头	Φ25	Φ24.6	14	25mm
RB32#	32#堵头	Φ31.8	Φ31.6	14	32mm
RB33.5#	33.5#堵头	Φ35	Φ34	13	33.5mm
RB38#	38#堵头	Φ37.8	Φ37.6	14	38mm
RB52#	52#堵头	Φ50.8	Φ50.8	14	52mm

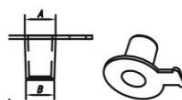

圆球堵头 (材质: PVC)

编号	名称	A	B	C	适配圆球内径
BP18#	18#堵头	Φ25	Φ19	54.5	18mm
BP16#	16#堵头	Φ25	Φ16.8	47.2	16mm
BP14#	14#堵头	Φ19.85	Φ14.1	39.5	14mm
BP12#	12#堵头	Φ19.3	Φ12.7	34.9	12mm
BP10#	10#堵头	Φ16.1	Φ10.4	30.2	10mm

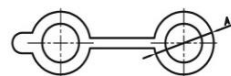
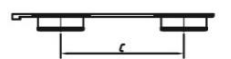

接受护套来样来图定制, 亦可根据产品样件、图纸设计护套。

- 燃油蒸汽和液体 ●
- 发动机冷却系统 ●
- 制动系统(低压) ●
- 液压动力转向系统 ●
- 空调系统 ●
- 曲轴箱通风管 ●
- DPF ●
- 尿素选择性催化还原系统 ●
- 润滑油冷却器 ●

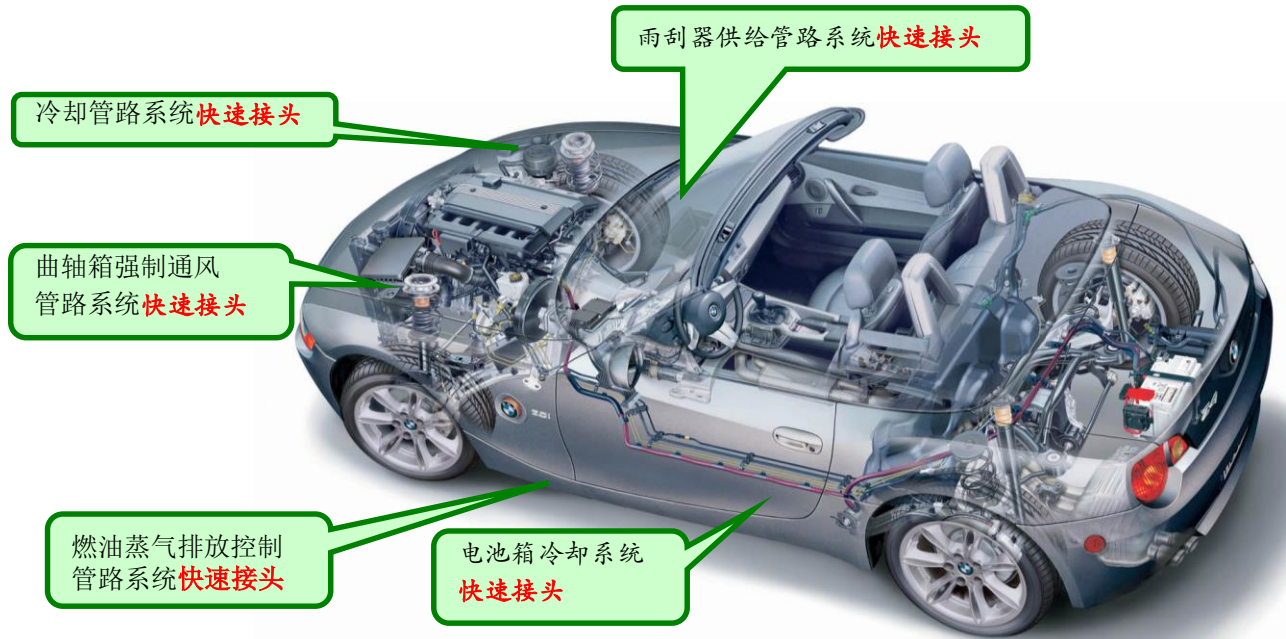
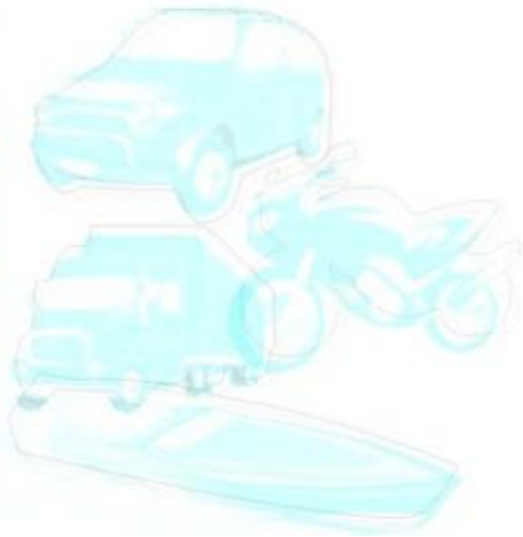

www.automotivequickconnect.com

临海市永恒汽配科技有限公司
 Linhai Yongheng Auto Parts Technology Co., Ltd.
 浙江省临海市江南区街道汇丰南路1289号2号厂房
 Building 2, No. 1289, Huifeng South Road, Jiangnan
 District, Linhai City, Zhejiang, China
 E-mail: Nicole@automotivequickconnect.com

